



November 2014

# SMBJ5V0(C)A - SMBJ170(C)A 600 Watt Transient Voltage Suppressors

## Features

- Glass-Passivated Junction
- 600 W Peak Pulse Power Capability on 10/1000  $\mu$ s Waveform.
- Excellent Clamping Capability
- Low-Incremental Surge Resistance
- Fast Response Time: Typically Less than 1.0 ps from 0 V to BV minimum for Unidirectional and 5.0 ns for Bidirectional
- Typical  $I_R$  Less than 1.0  $\mu$ A Above 10 V
- UL Certificate #E258596



**SMB/DO-214AA**

Band denotes cathode on unidirectional devices only. No band on bi-directional devices. Bi-directional types have CA suffix where electrical characteristics apply in both directions suitable for bi-directional applications.

## Absolute Maximum Ratings

Stresses exceeding the absolute maximum ratings may damage the device. The device may not function or be operable above the recommended operating conditions and stressing the parts to these levels is not recommended. In addition, extended exposure to stresses above the recommended operating conditions may affect device reliability. The absolute maximum ratings are stress ratings only. Values are at  $T_A = 25^\circ\text{C}$  unless otherwise noted.

Symbol	Parameter	Value	Unit
$P_{PPM}$	Peak Pulse Power Dissipation on 10/1000 $\mu$ s Waveform	600	W
$I_{PPM}$	Peak Pulse Current on 10/1000 $\mu$ s Waveform	See Table	A
$I_{FSM}$	Non-Repetitive Peak Forward Surge Current Superimposed on Rated Load (JEDEC Method) <sup>(1)</sup>	100	A
$T_{STG}$	Storage Temperature Range	-55 to 150	$^\circ\text{C}$
$T_J$	Operating Junction Temperature Range	-55 to 150	$^\circ\text{C}$

### Note:

1. Measured on 8.3 ms single half-sine wave or equivalent square wave: duty cycle = 4 pulses per minute maximum.

SMBJ5V0(C)A - SMBJ170(C)A — 600 Watt Transient Voltage Suppressors

## Electrical Characteristics

Values are at  $T_A = 25^\circ\text{C}$  unless otherwise noted.

Uni-Directional Bi-Directional (C) Device	Part Marking <sup>(2)</sup>	Reverse Stand-Off Voltage $V_{RWM}$ (V)	Breakdown Voltage $V_{BR}$ (V)		Test Current $I_T$ (mA)	Clamping Voltage at $I_{PPM}$ $V_C$ (V)	Peak Pulse Current $I_{PPM}$ (A)	Reverse Leakage at $V_{RWM}$ $I_R$ ( $\mu\text{A}$ ) <sup>(3)</sup>
			Min.	Max.				
SMBJ5V0(C)A	KE	5.0	6.40	7.00	10	9.2	65.2	800
SMBJ6V0(C)A	KG	6.0	6.67	7.37	10	10.3	58.3	800
SMBJ6V5(C)A	KK	6.5	7.22	7.98	10	11.2	53.6	500
SMBJ7V0(C)A	KM	7.0	7.78	8.60	10	12.0	50.0	200
SMBJ7V5(C)A	KP	7.5	8.33	9.21	1	12.9	46.5	100
SMBJ8V0(C)A	KR	8.0	8.89	9.83	1	13.6	44.1	50
SMBJ8V5(C)A	KT	8.5	9.44	10.4	1	14.4	41.7	20
SMBJ9V0(C)A	KV	9.0	10.0	11.1	1	15.4	39.0	10
SMBJ10(C)A	KX	10	11.1	12.8	1	17.0	35.3	5
SMBJ11(C)A	KZ	11	12.2	13.5	1	18.2	33.0	5
SMBJ12(C)A	LE	12	13.3	14.7	1	19.9	30.2	5
SMBJ13(C)A	LG	13	14.4	15.9	1	21.5	27.9	5
SMBJ14(C)A	LK	14	15.6	17.2	1	23.2	25.9	5
SMBJ15(C)A	LM	15	16.7	18.5	1	24.4	24.6	5
SMBJ16(C)A	LP	16	17.8	19.7	1	26.0	23.1	5
SMBJ17(C)A	LR	17	18.9	20.9	1	27.6	21.7	5
SMBJ18(C)A	LT	18	20.0	22.1	1	29.2	20.5	5
SMBJ20(C)A	LV	20	22.2	24.5	1	32.4	18.5	5
SMBJ22(C)A	LX	22	24.4	26.9	1	35.5	16.9	5
SMBJ24(C)A	LZ	24	26.7	29.5	1	38.9	15.4	5
SMBJ26(C)A	ME	26	28.9	31.9	1	42.1	14.3	5
SMBJ28(C)A	MG	28	31.1	34.4	1	45.4	13.2	5
SMBJ30(C)A	MK	30	33.3	36.8	1	48.4	12.4	5
SMBJ33(C)A	MM	33	36.7	40.6	1	53.3	11.3	5
SMBJ36(C)A	MP	36	40.0	44.2	1	58.1	10.3	5
SMBJ40(C)A	MR	40	44.4	49.1	1	64.5	9.3	5
SMBJ43(C)A	MT	43	47.8	52.8	1	69.4	8.6	5
SMBJ45(C)A	MV	45	50.0	55.3	1	72.7	8.3	5
SMBJ48(C)A	MX	48	53.3	58.9	1	77.4	7.8	5
SMBJ51(C)A	MZ	51	56.7	62.7	1	82.4	7.3	5
SMBJ54(C)A	NE	54	60.0	66.3	1	87.1	6.9	5
SMBJ58(C)A	NG	58	64.4	71.2	1	93.6	6.4	5
SMBJ60(C)A	NK	60	66.7	73.7	1	96.8	6.2	5
SMBJ64(C)A	NM	64	71.1	78.6	1	103.0	5.8	5
SMBJ70(C)A	NP	70	77.8	86.0	1	113.0	5.3	5
SMBJ75(C)A	NR	75	83.3	92.1	1	121.0	5.0	5
SMBJ78(C)A	NT	78	86.7	95.8	1	126.0	4.8	5

### Notes:

2. Color band denotes cathode on unidirectional devices only. No color band on bidirectional devices.
3. For bidirectional parts with  $V_{RWM} < 10$  V, the  $I_R$  max limit is doubled.

**Electrical Characteristics** (Continued)Values are at  $T_A = 25^\circ\text{C}$  unless otherwise noted.

Uni-Directional Bi-Directional (C) Device	Part Marking <sup>(2)</sup>	Reverse Stand-Off Voltage $V_{RWM}$ (V)	Breakdown Voltage $V_{BR}$ (V)		Test Current $I_T$ (mA)	Clamping Voltage at $I_{PPM}$ $V_C$ (V)	Peak Pulse Current $I_{PPM}$ (A)	Reverse Leakage at $V_{RWM}$ $I_R$ ( $\mu\text{A}$ ) <sup>(3)</sup>
			Min.	Max.				
SMBJ85(C)A	NV	85	94.4	104.0	1	137.0	4.4	5
SMBJ90(C)A	NX	90	100.0	111.0	1	146.0	4.1	5
SMBJ100(C)A	NZ	100	111.0	123.0	1	162.0	3.7	5
SMBJ110(C)A	PE	110	122.0	135.0	1	177.0	3.4	5
SMBJ120(C)A	PG	120	133.0	147.0	1	193.0	3.1	5
SMBJ130(C)A	PK	130	144.0	159.0	1	209.0	2.9	5
SMBJ150(C)A	PM	150	167.0	185.0	1	243.0	2.5	5
SMBJ160(C)A	PP	160	178.0	197.0	1	259.0	2.3	5
SMBJ170(C)A	PR	170	189.0	209.0	1	275.0	2.2	5

**Notes:**

- Color band denotes cathode on unidirectional devices only. No color band on bidirectional devices.
- For bidirectional parts with  $V_{RWM} < 10$  V, the  $I_R$  max limit is doubled.

## Typical Performance Characteristics

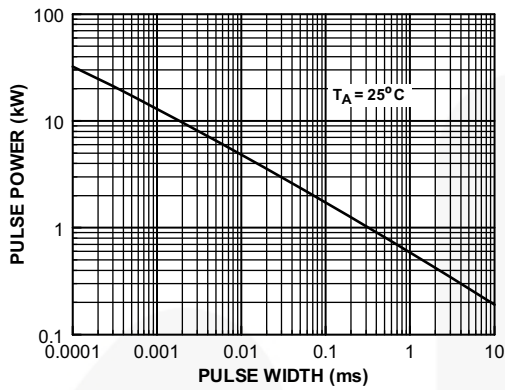

Figure 1. Peak Pulse Power Rating Curve

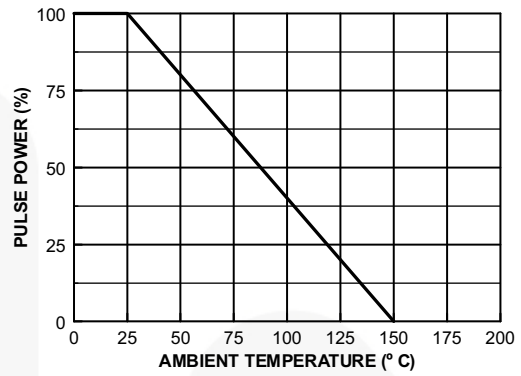

Figure 2. Pulse Derating Curve

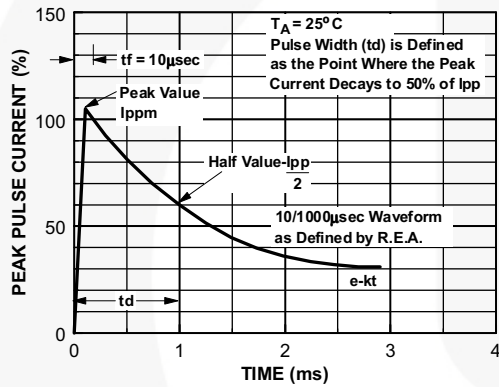

Figure 3. Pulse Waveform

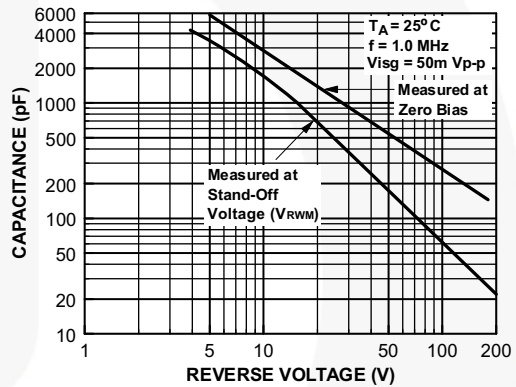

Figure 4. Junction Capacitance

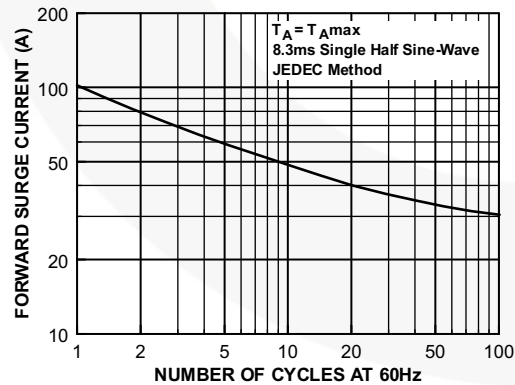
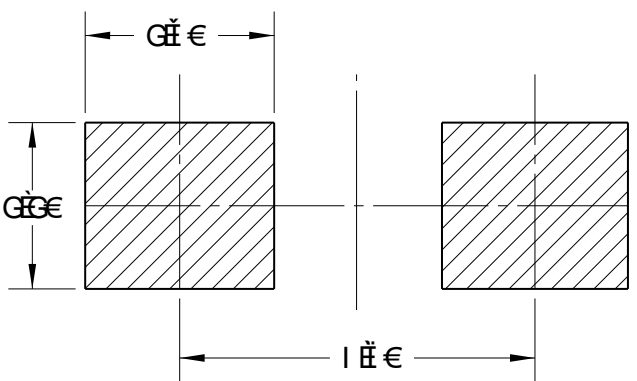
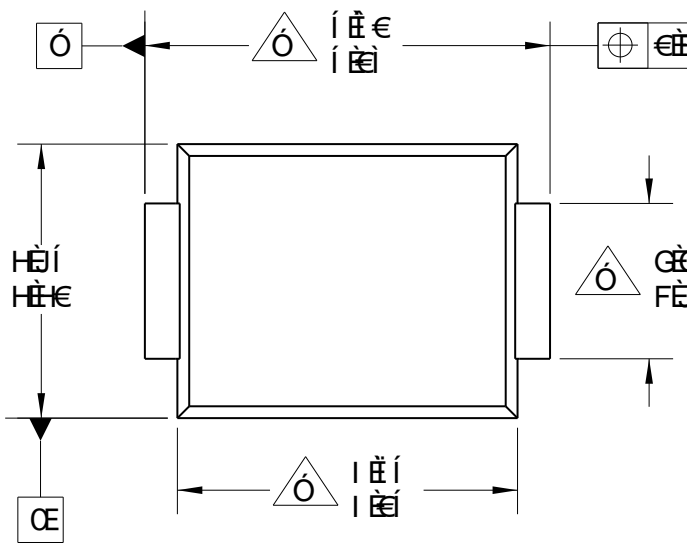

Figure 5. Non-Repetitive Surge Current

VP:SHOBY Φ ΟΑΒΡΡΑΟΔΙΛΟΟΥΥΑΥΑΚΩΚΩΡΦΩΑΜΤ ΘΕΡΦΟΝΟΥΛΙΟΥΔΙΟΥΔΕΒΡΦΒΗΛΑΜΙΟ  
 VP:OOUΦΑΡΠΕΣΣΟΤ ΘΕΔΑΥΡΟΔΑΡΦΑΒΕΛΑΟΟΟΦΟΑΚΑΔΑΙΟΥΔΙΟΥΔΕΒΡΑΒΑΜΤ ΘΑΟΟ  
 VU:ΑΒΕΡΦΩΑΜΤ ΘΕΡΦΟΝΟΥΛΙΟΥΔΙΟΥΔΕΒΡΑΒΑΜΤ ΘΑΟΟΔΑΙΟΥΔΙΟΥΔΕΒΡΑΒΑΜΤ ΘΑΟΟ  
 Υ ΦΑΡΑΦΑΡΑΒΟΥΔΕΒΡΑΒΑΜΤ ΘΑΟΟΔΑΙΟΥΔΙΟΥΔΕΒΡΑΒΑΜΤ ΘΑΟΟΔΑΙΟΥΔΙΟΥΔΕΒΡΑΒΑΜΤ ΘΑΟΟ  
 ΟΥΔΕΒΡΑΒΑΜΤ ΘΑΟΟΔΑΙΟΥΔΙΟΥΔΕΒΡΑΒΑΜΤ ΘΑΟΟΔΑΙΟΥΔΙΟΥΔΕΒΡΑΒΑΜΤ ΘΑΟΟΔΑΙΟΥΔΙΟΥΔΕΒΡΑΒΑΜΤ ΘΑΟΟ  
 ΟΥΔΕΒΡΑΒΑΜΤ ΘΑΟΟΔΑΙΟΥΔΙΟΥΔΕΒΡΑΒΑΜΤ ΘΑΟΟΔΑΙΟΥΔΙΟΥΔΕΒΡΑΒΑΜΤ ΘΑΟΟΔΑΙΟΥΔΙΟΥΔΕΒΡΑΒΑΜΤ ΘΑΟΟ  
 ΥΡΑΡΑΒΑΜΤ ΘΑΟΟΔΑΙΟΥΔΙΟΥΔΕΒΡΑΒΑΜΤ ΘΑΟΟΔΑΙΟΥΔΙΟΥΔΕΒΡΑΒΑΜΤ ΘΑΟΟΔΑΙΟΥΔΙΟΥΔΕΒΡΑΒΑΜΤ ΘΑΟΟ

ΥΟΧΩΦΒΨ			
ΡΟΨ	ΟΟΥΟΨΦΩΦ	ΟΕ/Ο	ΟΨΘΨΨ
F	ΨΟΟΑΨΟΑΨΨΟ	FJT ΟΨΘΨ	ΨΟΟΑΨΨΨ



ΣΩΡ ΟΑΨΕ/ΝΟΥΡΑΨΟΟΥΤ Τ ΟΡ ΟΕΦ/Ψ

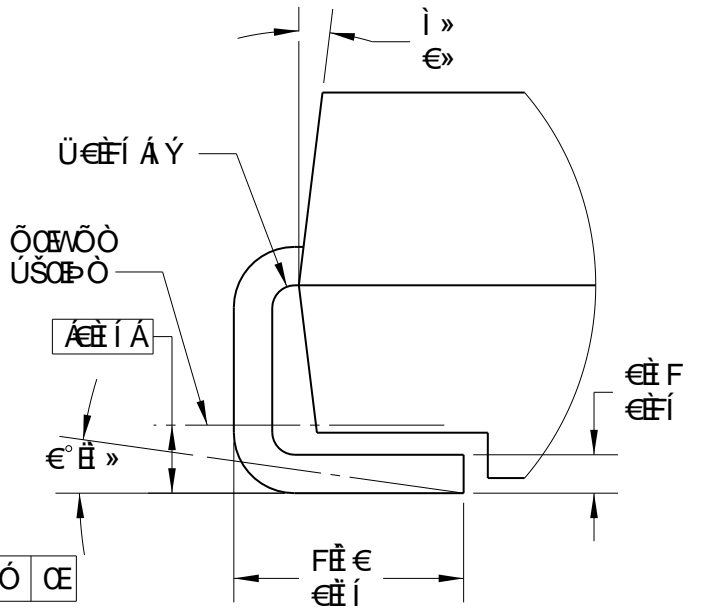
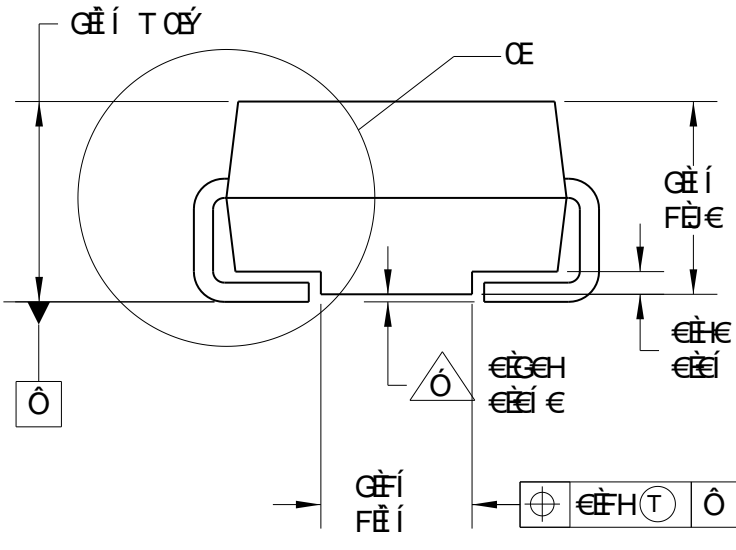

ΟΟΝΚΣΑΑ  
 ΨΟΟΟ/ΓΑΜ

ΡΥΝΟΨΚ





ΑΨΕΨ ΟΟΨΥΑ ΡΟΨΟΑ ΡΥΝΟΨΟΨΡΑΨΨΤ ΨΑΨΑ  
 ΡΟΨΟΨΟΨΓΦ ΑΨΕΨΦ/ΨΡΑΨΕ  
 Ο ΟΨΨΑ ΡΥΝΟΨΤ ΨΨΥ ΡΟΨΟΨΑ ΨΒΑΨΩΕ  
 ΑΨΕΨΣΑΨ ΟΡΨΨΡΑΨΑΨΟΑΨ Τ ΣΨ ΟΨΟΨΨ  
 ΑΨΕΨΤ ΟΡΨΨΡΑΨΕΨΟΨΨΨΨΨΑΨΑΨΨΨΨΨ  
 ΑΨ ΨΟΨΑΨΨΡΑΨΕΨΑΨΨΨΑΨΨΨΨΨΨΨΨΨ  
 ΑΨΕΨΤ ΟΡΨΨΡΑΨΕΨΑΨΨΨΨΨΨΨΨΨΨΨΨ  
 ΨΦ ΨΨΨΨ Ψ  
 ΑΨΕΨΣΩΡ ΟΑΨΕ/ΝΟΥΡΑΨΨΟΨ Τ Ψ Ψ Ψ Γ Ε Ψ Ψ  
 ΑΨΕΨΨΨΨ Ψ ΟΑΨΨΑΨ Ψ Ψ Ψ Ψ Ψ Ψ Ψ Ψ Ψ

ΨΨΨΨΨΨ	ΟΕ/Ο									
ΟΨΨ ΨΚ ΟΨΨΨΨ ΨΨΨ	FJT ΟΨΘΨ									
ΟΡΟΨΨΚ ΨΟΨΨ		ΓΨΨΨΤ ΟΑΡΟΨΨ ΟΨΓΦ ΑΨΕΨΦ/ΨΡΑΨΕ								
ΨΨΨΨΨΚ ΨΨΨΨΨ										
ΨΨΨΨΨΚ ΨΨΨ ΨΨΨΨ										
ΨΨΨΨΨΨ		<table border="1"> <tr> <td>ΨΨΨΨ</td> <td>ΨΨΨ</td> <td>ΟΨΨ ΨΨΨΨΨΨ</td> <td>ΨΨΚ</td> </tr> <tr> <td>FJT</td> <td>ΨΨΨ</td> <td>T SV ΨΨΨ ΓΦ ΨΨ</td> <td>F</td> </tr> </table>	ΨΨΨΨ	ΨΨΨ	ΟΨΨ ΨΨΨΨΨΨ	ΨΨΚ	FJT	ΨΨΨ	T SV ΨΨΨ ΓΦ ΨΨ	F
ΨΨΨΨ	ΨΨΨ	ΟΨΨ ΨΨΨΨΨΨ	ΨΨΚ							
FJT	ΨΨΨ	T SV ΨΨΨ ΓΦ ΨΨ	F							



**TRADEMARKS**

The following includes registered and unregistered trademarks and service marks, owned by Fairchild Semiconductor and/or its global subsidiaries, and is not intended to be an exhaustive list of all such trademarks.

- |   |  |   |   |
|---|--|---|---|
| AccuPower™  | F-PFS™   | OPTOPLANAR®   |  |
| Awinda®   | FRFET®   |  | TinyBoost®  |
| AX-CAP®*  | Global Power Resource <sup>SM</sup>            | PowerTrench®  | TinyBuck®   |
| BitSiC™   | GreenBridge™                                   | PowerXS™  | TinyCalc™   |
| Build it Now™   | Green FPS™                                     | Programmable Active Droop™  | TinyLogic®  |
| CorePLUS™   | Green FPS™ e-Series™                           | QFET®   | TINYOPTO™   |
| CorePOWER™  | Gmax™  | QS™   | TinyPower™  |
| CROSSVOL™   | GTO™   | Quiet Series™   | TinyPWM™  |
| CTL™  | IntelliMAX™                                    | RapidConfigure™   | TinyWire™   |
| Current Transfer Logic™   | ISOPLANAR™                                     |  | TranSiC™  |
| DEUXPEED®   | Making Small Speakers Sound Louder and Better™ | Saving our world, 1mW/W/kW at a time™   | TriFault Detect™  |
| Dual Cool™  | MegaBuck™                                      | SignalWise™   | TRUECURRENT®*   |
| EcoSPARK®   | MICROCOUPLER™                                  | SmartMax™   | μSerDes™  |
| EfficientMax™   | MicroFET™                                      | SMART START™  |  |
| ESBC™   | MicroPak™                                      | Solutions for Your Success™   | UHC®  |
|  | MicroPak2™                                     | SPM®  | Ultra FRFET™  |
| Fairchild®  | MillerDrive™                                   | STEALTH™  | UniFET™   |
| Fairchild Semiconductor®  | MotionMax™                                     | SuperFET®   | VCX™  |
| FACT Quiet Series™  | MotionGrid®                                    | SuperSOT™-3   | VisualMax™  |
| FACT®   | MTi®   | SuperSOT™-6   | VoltagePlus™  |
| FAST®   | MTx®   | SuperSOT™-8   | XS™   |
| FastvCore™  | MVN®   | SupreMOS®   | Xsens™  |
| FETBench™   | mWSaver®                                       | SyncFET™  | 仙童™   |
| FPS™  | OptoHiT™                                       | Sync-Lock™  |   |
|   | OPTOLOGIC®                                     |   |   |

\* Trademarks of System General Corporation, used under license by Fairchild Semiconductor.

**DISCLAIMER**

FAIRCHILD SEMICONDUCTOR RESERVES THE RIGHT TO MAKE CHANGES WITHOUT FURTHER NOTICE TO ANY PRODUCTS HEREIN TO IMPROVE RELIABILITY, FUNCTION, OR DESIGN. TO OBTAIN THE LATEST, MOST UP-TO-DATE DATASHEET AND PRODUCT INFORMATION, VISIT OUR WEBSITE AT [HTTP://WWW.FAIRCHILDSEMI.COM](http://www.fairchildsemi.com). FAIRCHILD DOES NOT ASSUME ANY LIABILITY ARISING OUT OF THE APPLICATION OR USE OF ANY PRODUCT OR CIRCUIT DESCRIBED HEREIN; NEITHER DOES IT CONVEY ANY LICENSE UNDER ITS PATENT RIGHTS, NOR THE RIGHTS OF OTHERS. THESE SPECIFICATIONS DO NOT EXPAND THE TERMS OF FAIRCHILD'S WORLDWIDE TERMS AND CONDITIONS, SPECIFICALLY THE WARRANTY THEREIN, WHICH COVERS THESE PRODUCTS.

**LIFE SUPPORT POLICY**

FAIRCHILD'S PRODUCTS ARE NOT AUTHORIZED FOR USE AS CRITICAL COMPONENTS IN LIFE SUPPORT DEVICES OR SYSTEMS WITHOUT THE EXPRESS WRITTEN APPROVAL OF FAIRCHILD SEMICONDUCTOR CORPORATION.

As used herein:

1. Life support devices or systems are devices or systems which, (a) are intended for surgical implant into the body or (b) support or sustain life, and (c) whose failure to perform when properly used in accordance with instructions for use provided in the labeling, can be reasonably expected to result in a significant injury of the user.
2. A critical component in any component of a life support, device, or system whose failure to perform can be reasonably expected to cause the failure of the life support device or system, or to affect its safety or effectiveness.

**ANTI-COUNTERFEITING POLICY**

Fairchild Semiconductor Corporation's Anti-Counterfeiting Policy. Fairchild's Anti-Counterfeiting Policy is also stated on our external website, [www.fairchildsemi.com](http://www.fairchildsemi.com), under Sales Support.

Counterfeiting of semiconductor parts is a growing problem in the industry. All manufacturers of semiconductor products are experiencing counterfeiting of their parts. Customers who inadvertently purchase counterfeit parts experience many problems such as loss of brand reputation, substandard performance, failed applications, and increased cost of production and manufacturing delays. Fairchild is taking strong measures to protect ourselves and our customers from the proliferation of counterfeit parts. Fairchild strongly encourages customers to purchase Fairchild parts either directly from Fairchild or from Authorized Fairchild Distributors who are listed by country on our web page cited above. Products customers buy either from Fairchild directly or from Authorized Fairchild Distributors are genuine parts, have full traceability, meet Fairchild's quality standards for handling and storage and provide access to Fairchild's full range of up-to-date technical and product information. Fairchild and our Authorized Distributors will stand behind all warranties and will appropriately address any warranty issues that may arise. Fairchild will not provide any warranty coverage or other assistance for parts bought from Unauthorized Sources. Fairchild is committed to combat this global problem and encourage our customers to do their part in stopping this practice by buying direct or from authorized distributors.

**PRODUCT STATUS DEFINITIONS**

**Definition of Terms**

Datasheet Identification	Product Status	Definition
Advance Information	Formative / In Design	Datasheet contains the design specifications for product development. Specifications may change in any manner without notice.
Preliminary	First Production	Datasheet contains preliminary data; supplementary data will be published at a later date. Fairchild Semiconductor reserves the right to make changes at any time without notice to improve design.
No Identification Needed	Full Production	Datasheet contains final specifications. Fairchild Semiconductor reserves the right to make changes at any time without notice to improve the design.
Obsolete	Not In Production	Datasheet contains specifications on a product that is discontinued by Fairchild Semiconductor. The datasheet is for reference information only.

Rev. I72

# Mouser Electronics

Authorized Distributor

Click to View Pricing, Inventory, Delivery & Lifecycle Information:

[Fairchild Semiconductor:](#)

[SMBJ11A](#)