



# PESD1FLEX

FlexRay bus ESD protection diode

Rev. 02 — 15 February 2008

Product data sheet

## 1. Product profile

### 1.1 General description

PESD1FLEX in a small SOT23 (TO-236AB) Surface-Mounted Device (SMD) plastic package designed to protect two automotive FlexRay bus lines from the damage caused by ElectroStatic Discharge (ESD) and other transients.

### 1.2 Features

- Due to the integrated diode structure only one small SOT23 package is needed to protect two FlexRay bus lines
- Max. peak pulse power:  $P_{PP} = 200 \text{ W}$  at  $t_p = 8/20 \mu\text{s}$
- Low clamping voltage:  $V_{CL} = 40 \text{ V}$  at  $I_{PP} = 1 \text{ A}$
- Ultra low leakage current:  $I_{RM} < 1 \text{ nA}$
- Typ. diode capacitance matching:  $\Delta C_d/C_d = 0.1 \%$
- ESD protection up to 23 kV
- IEC 61000-4-2, level 4 (ESD)
- IEC 61000-4-5 (surge);  $I_{PP} = 3 \text{ A}$  at  $t_p = 8/20 \mu\text{s}$
- Small SMD plastic package

### 1.3 Applications

- FlexRay bus protection
- Automotive applications

### 1.4 Quick reference data

**Table 1. Quick reference data**

$T_{amb} = 25^\circ\text{C}$  unless otherwise specified.

| Symbol           | Parameter                | Conditions                             | Min | Typ | Max | Unit |
|------------------|--------------------------|--|-----|-----|-----|------|
| <b>Per diode</b> |                          |  |     |     |     |      |
| $V_{RWM}$        | reverse standoff voltage |  | -   | -   | 24  | V    |
| $C_d$            | diode capacitance        | $f = 5 \text{ MHz}; V_R = 0 \text{ V}$ | -   | 11  | 17  | pF   |

## 2. Pinning information

**Table 2. Pinning**

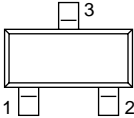
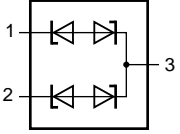
| Pin | Description    | Simplified outline   | Symbol  |
|-----|----------------|--|---|
| 1   | cathode 1      |  |  |
| 2   | cathode 2      |  |   |
| 3   | common cathode |  |   |

006aaa155

## 3. Ordering information

**Table 3. Ordering information**

| Type number | Package |  |         |
|-------------|---------|--|---------|
|             | Name    | Description                              | Version |
| PESD1FLEX   | -       | plastic surface-mounted package; 3 leads | SOT23   |

## 4. Marking

**Table 4. Marking codes**

| Type number | Marking code <sup>[1]</sup> |
|-------------|-----------------------------|
| PESD1FLEX   | ZJ*                         |

- [1] \* = -: made in Hong Kong  
 \* = p: made in Hong Kong  
 \* = t: made in Malaysia  
 \* = W: made in China

## 5. Limiting values

**Table 5. Limiting values**

In accordance with the Absolute Maximum Rating System (IEC 60134).

| Symbol            | Parameter            | Conditions               | Min      | Max  | Unit |
|-------------------|----------------------|--------------------------|----------|------|------|
| <b>Per diode</b>  |                      |                          |          |      |      |
| P <sub>PP</sub>   | peak pulse power     | t <sub>p</sub> = 8/20 μs | [1][2] - | 200  | W    |
| I <sub>PP</sub>   | peak pulse current   | t <sub>p</sub> = 8/20 μs | [1][2] - | 3    | A    |
| <b>Per device</b> |                      |                          |          |      |      |
| T <sub>j</sub>    | junction temperature |                          | -        | 150  | °C   |
| T <sub>amb</sub>  | ambient temperature  |                          | -65      | +150 | °C   |
| T <sub>stg</sub>  | storage temperature  |                          | -65      | +150 | °C   |

[1] Non-repetitive current pulse 8/20 μs exponential decay waveform according to IEC 61000-4-5.

[2] Measured from pin 1 to 3 or 2 to 3.

**Table 6. ESD maximum ratings**

| Symbol           | Parameter                       | Conditions                        | Min    | Max | Unit  |
|------------------|---------------------------------|-----------------------------------|--------|-----|-------|
| <b>Per diode</b> |                                 |                                   |        |     |       |
| $V_{ESD}$        | electrostatic discharge voltage | IEC 61000-4-2 (contact discharge) | [1][2] | -   | 23 kV |
|                  |                                 | MIL-STD-883 (human body model)    | -      | 10  | kV    |

[1] Device stressed with ten non-repetitive ESD pulses.

[2] Measured from pin 1 to 3 or 2 to 3.

**Table 7. ESD standards compliance**

| Standard                                | Conditions                      |
|---|---------------------------------|
| <b>Per diode</b>                        |                                 |
| IEC 61000-4-2; level 4 (ESD)            | > 15 kV (air); > 8 kV (contact) |
| MIL-STD-883; class 3 (human body model) | > 4 kV                          |

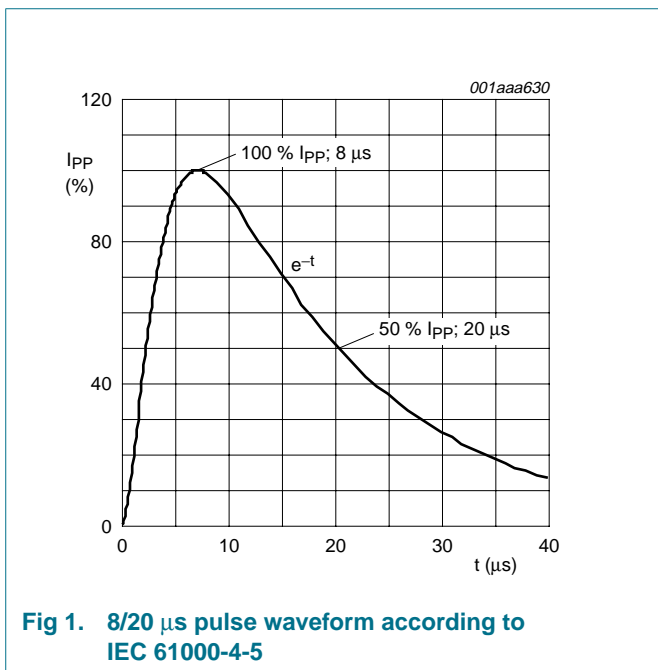

**Fig 1. 8/20  $\mu s$  pulse waveform according to IEC 61000-4-5**

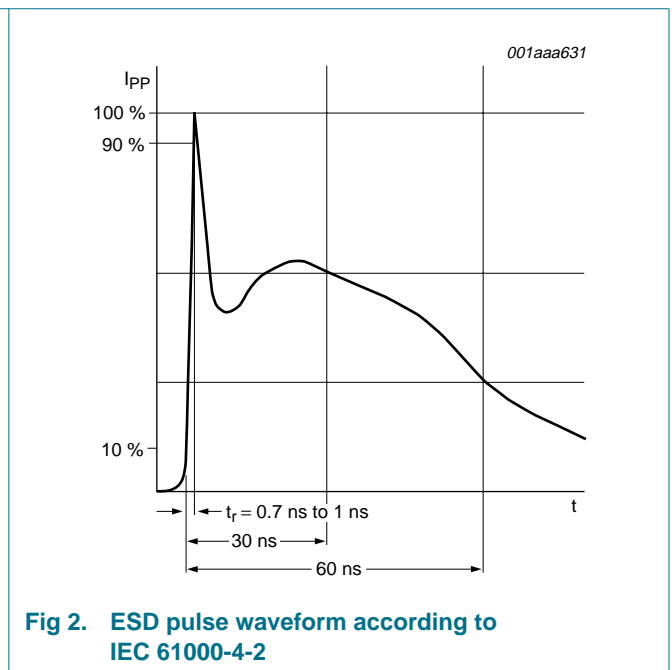

**Fig 2. ESD pulse waveform according to IEC 61000-4-2**

## 6. Characteristics

**Table 8. Characteristics**

$T_{amb} = 25\text{ }^{\circ}\text{C}$  unless otherwise specified.

| Symbol           | Parameter                  | Conditions                             | Min    | Typ  | Max  | Unit     |
|------------------|----------------------------|--|--------|------|------|----------|
| <b>Per diode</b> |                            |  |        |      |      |          |
| $V_{RWM}$        | reverse standoff voltage   |  | -      | -    | 24   | V        |
| $I_{RM}$         | reverse leakage current    | $V_{RWM} = 24\text{ V}$                | -      | < 1  | 50   | nA       |
| $V_{BR}$         | breakdown voltage          | $I_R = 5\text{ mA}$                    | 25.4   | 27.8 | 30.3 | V        |
| $C_d$            | diode capacitance          | $f = 5\text{ MHz}; V_R = 0\text{ V}$   | -      | 11   | 17   | pF       |
| $\Delta C_d/C_d$ | diode capacitance matching |  | [1]    |      |      |          |
|                  |                            | $f = 5\text{ MHz}; V_R = 0\text{ V}$   | -      | 0.1  | -    | %        |
|                  |                            | $f = 5\text{ MHz}; V_R = 2.5\text{ V}$ | -      | 0.1  | -    | %        |
| $V_{CL}$         | clamping voltage           |  | [2][3] |      |      |          |
|                  |                            | $I_{PP} = 1\text{ A}$                  | -      | -    | 40   | V        |
|                  |                            | $I_{PP} = 3\text{ A}$                  | -      | -    | 70   | V        |
| $r_{dif}$        | differential resistance    | $I_R = 1\text{ mA}$                    | -      | -    | 300  | $\Omega$ |

[1]  $\Delta C_d$  is the difference of the capacitance measured between pin 1 and pin 3 and the capacitance measured between pin 2 and pin 3.

[2] Non-repetitive current pulse 8/20  $\mu\text{s}$  exponential decay waveform according to IEC 61000-4-5.

[3] Measured from pin 1 to 3 or 2 to 3.

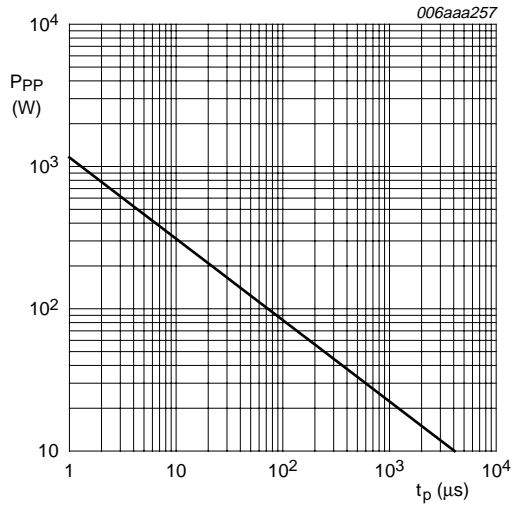

Fig 3. Peak pulse power as a function of exponential pulse duration; typical values

$T_{amb} = 25\text{ °C}$

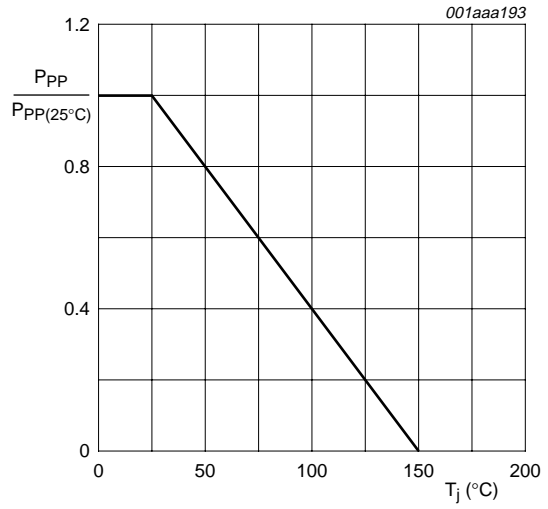

Fig 4. Relative variation of peak pulse power as a function of junction temperature; typical values

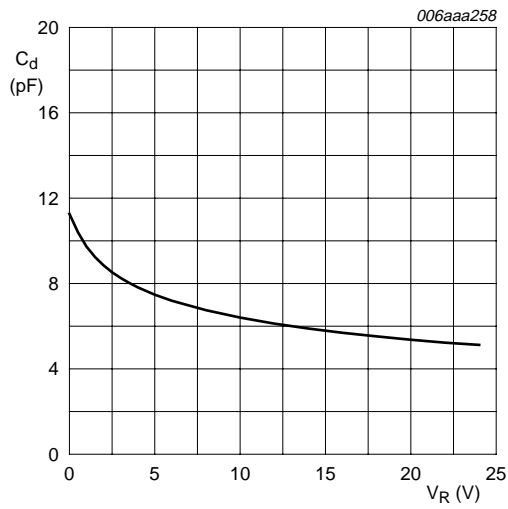

Fig 5. Diode capacitance as a function of reverse voltage; typical values

$f = 5\text{ MHz}; T_{amb} = 25\text{ °C}$

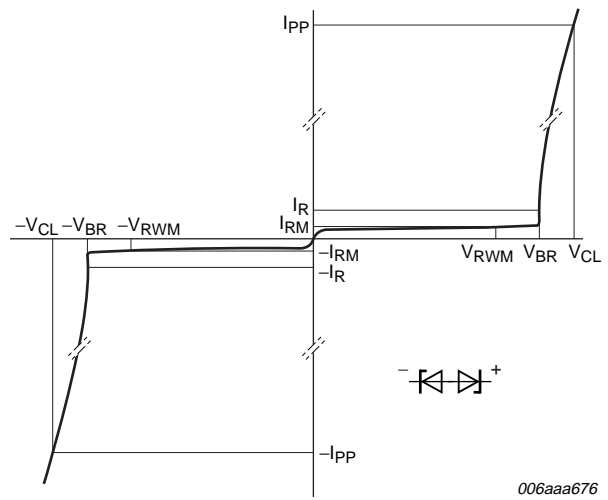
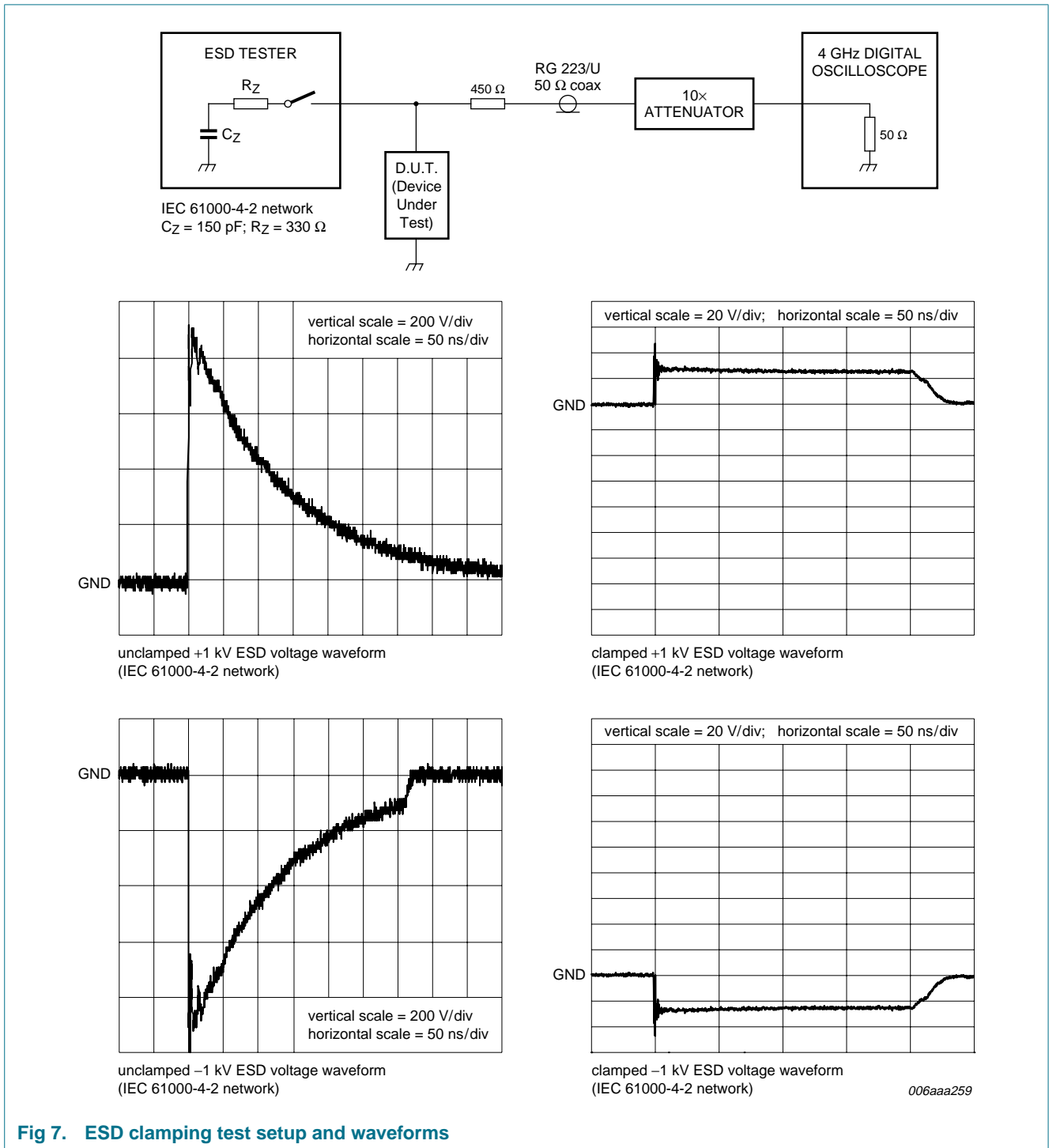

Fig 6. V-I characteristics for a bidirectional ESD protection diode



**Fig 7. ESD clamping test setup and waveforms**

## 7. Application information

The PESD1FLEX is designed for the protection of two automotive FlexRay data lines from the damage caused by ESD and surge pulses. The device supports a FlexRay data rate of 10 Mbit/s. The PESD1FLEX provides a surge capability of up to 200 W per line for an 8/20  $\mu$ s waveform.

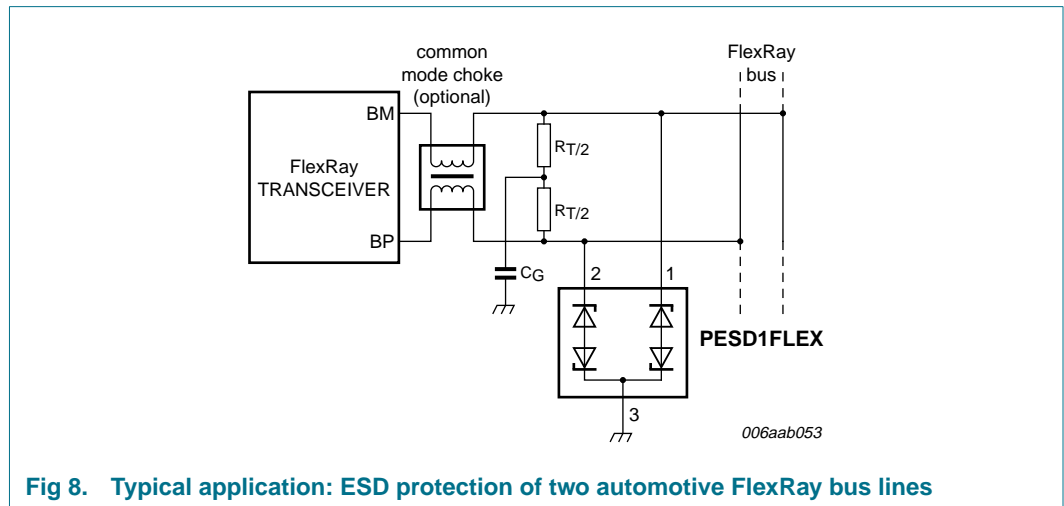

**Fig 8. Typical application: ESD protection of two automotive FlexRay bus lines**

### Circuit board layout and protection device placement:

Circuit board layout is critical for the suppression of ESD, Electrical Fast Transient (EFT) and surge transients. The following guidelines are recommended:

1. Place the PESD1FLEX as close to the input terminal or connector as possible.
2. The path length between the PESD1FLEX and the protected line should be minimized.
3. Keep parallel signal paths to a minimum.
4. Avoid running protection conductors in parallel with unprotected conductors.
5. Minimize all Printed-Circuit Board (PCB) conductive loops including power and ground loops.
6. Minimize the length of the transient return path to ground.
7. Avoid using shared transient return paths to a common ground point.
8. Ground planes should be used whenever possible. For multilayer PCBs, use ground vias.

## 8. Package outline

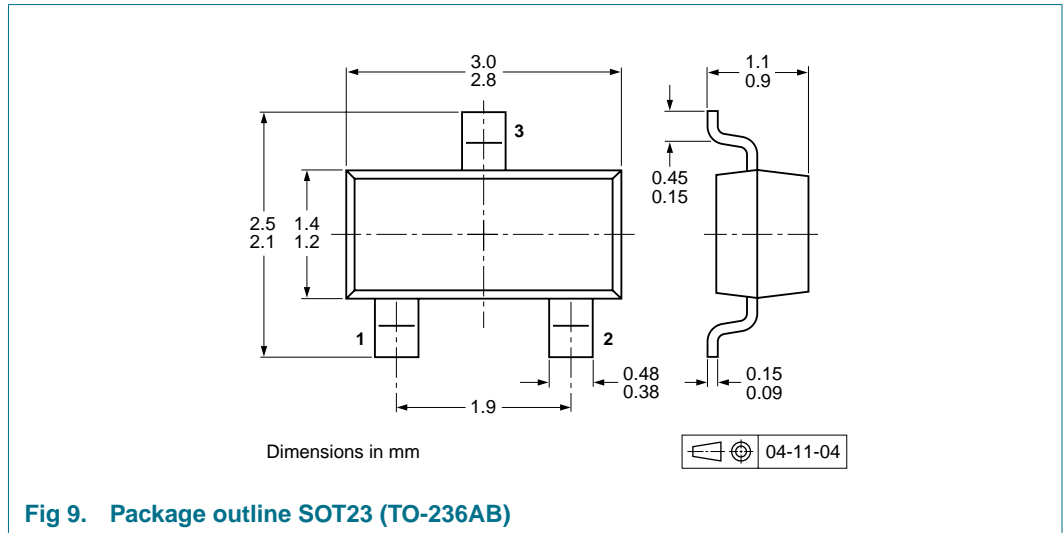

## 9. Packing information

**Table 9. Packing methods**

The indicated -xxx are the last three digits of the 12NC ordering code.<sup>[1]</sup>

| Type number | Package | Description                    | Packing quantity |       |
|-------------|---------|--------------------------------|------------------|-------|
|             |         |                                | 3000             | 10000 |
| PESD1FLEX   | SOT23   | 4 mm pitch, 8 mm tape and reel | -215             | -235  |

[1] For further information and the availability of packing methods, see [Section 13](#).



## 10. Soldering

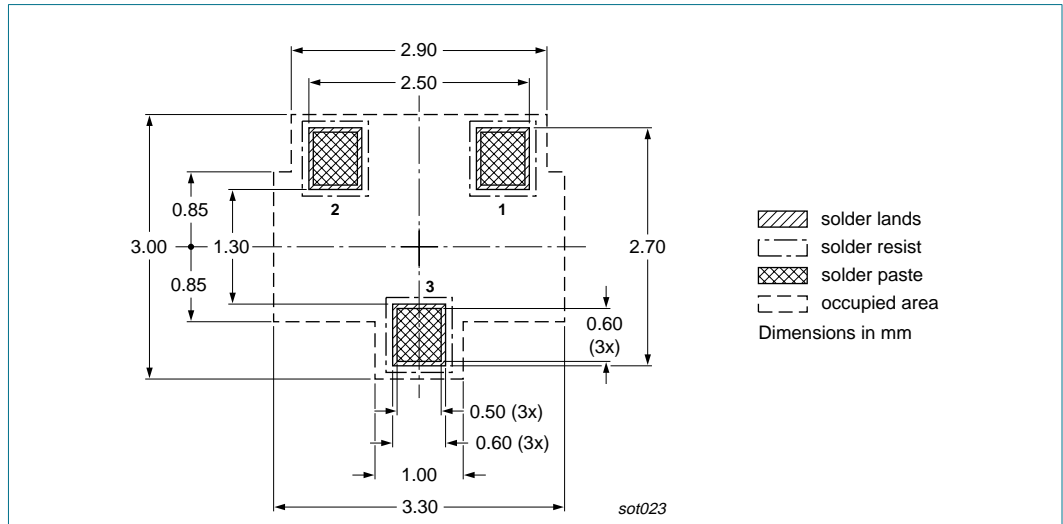

**Fig 10. Reflow soldering footprint SOT23 (TO-236AB)**

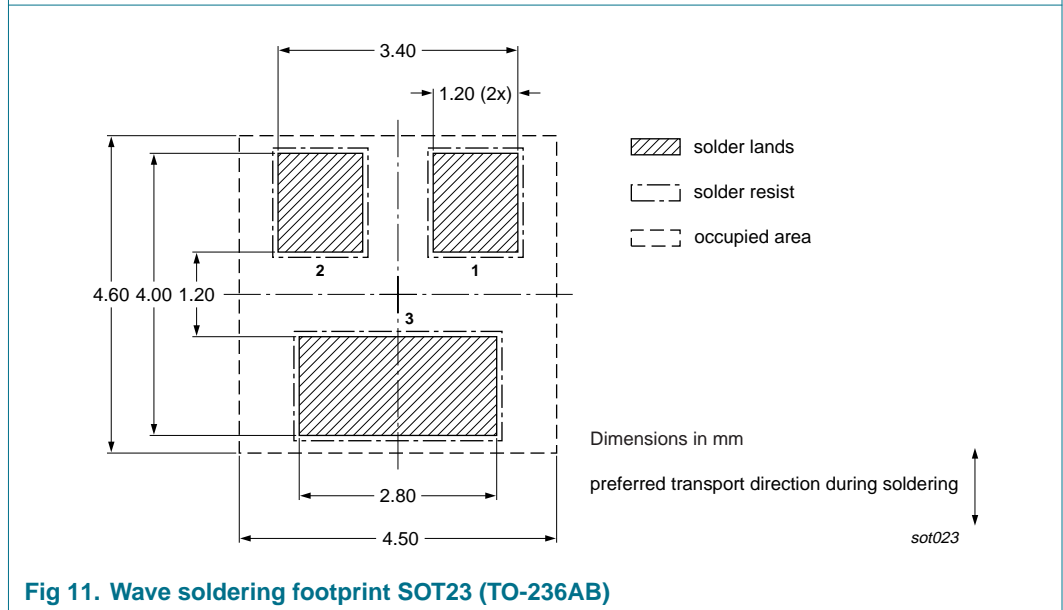

**Fig 11. Wave soldering footprint SOT23 (TO-236AB)**

## 11. Revision history

Table 10. Revision history

| Document ID    | Release date | Data sheet status  | Change notice  | Supersedes  |
|----------------|--------------|--------------------|--|-------------|
| PESD1FLEX_2    | 20080215     | Product data sheet | -  | PESD1FLEX_1 |
| Modifications: |              |                    |  |             |
|                |              |                    | <ul style="list-style-type: none"><li>• <a href="#">Section 1.2 "Features"</a>: list item for diode capacitance matching added</li><li>• <a href="#">Table 8 "Characteristics"</a>: <math>\Delta C_d/C_d</math> diode capacitance matching added</li></ul> |             |
| PESD1FLEX_1    | 20070521     | Product data sheet | -  | -           |

## 12. Legal information

### 12.1 Data sheet status

| Document status <sup>[1][2]</sup> | Product status <sup>[3]</sup> | Definition  |
|-----------------------------------|-------------------------------|---|
| Objective [short] data sheet      | Development                   | This document contains data from the objective specification for product development. |
| Preliminary [short] data sheet    | Qualification                 | This document contains data from the preliminary specification.                       |
| Product [short] data sheet        | Production                    | This document contains the product specification.                                     |

[1] Please consult the most recently issued document before initiating or completing a design.

[2] The term 'short data sheet' is explained in section "Definitions".

[3] The product status of device(s) described in this document may have changed since this document was published and may differ in case of multiple devices. The latest product status information is available on the Internet at URL <http://www.nxp.com>.

### 12.2 Definitions

**Draft** — The document is a draft version only. The content is still under internal review and subject to formal approval, which may result in modifications or additions. NXP Semiconductors does not give any representations or warranties as to the accuracy or completeness of information included herein and shall have no liability for the consequences of use of such information.

**Short data sheet** — A short data sheet is an extract from a full data sheet with the same product type number(s) and title. A short data sheet is intended for quick reference only and should not be relied upon to contain detailed and full information. For detailed and full information see the relevant full data sheet, which is available on request via the local NXP Semiconductors sales office. In case of any inconsistency or conflict with the short data sheet, the full data sheet shall prevail.

### 12.3 Disclaimers

**General** — Information in this document is believed to be accurate and reliable. However, NXP Semiconductors does not give any representations or warranties, expressed or implied, as to the accuracy or completeness of such information and shall have no liability for the consequences of use of such information.

**Right to make changes** — NXP Semiconductors reserves the right to make changes to information published in this document, including without limitation specifications and product descriptions, at any time and without notice. This document supersedes and replaces all information supplied prior to the publication hereof.

**Suitability for use** — NXP Semiconductors products are not designed, authorized or warranted to be suitable for use in medical, military, aircraft, space or life support equipment, nor in applications where failure or

malfunction of an NXP Semiconductors product can reasonably be expected to result in personal injury, death or severe property or environmental damage. NXP Semiconductors accepts no liability for inclusion and/or use of NXP Semiconductors products in such equipment or applications and therefore such inclusion and/or use is at the customer's own risk.

**Applications** — Applications that are described herein for any of these products are for illustrative purposes only. NXP Semiconductors makes no representation or warranty that such applications will be suitable for the specified use without further testing or modification.

**Limiting values** — Stress above one or more limiting values (as defined in the Absolute Maximum Ratings System of IEC 60134) may cause permanent damage to the device. Limiting values are stress ratings only and operation of the device at these or any other conditions above those given in the Characteristics sections of this document is not implied. Exposure to limiting values for extended periods may affect device reliability.

**Terms and conditions of sale** — NXP Semiconductors products are sold subject to the general terms and conditions of commercial sale, as published at <http://www.nxp.com/profile/terms>, including those pertaining to warranty, intellectual property rights infringement and limitation of liability, unless explicitly otherwise agreed to in writing by NXP Semiconductors. In case of any inconsistency or conflict between information in this document and such terms and conditions, the latter will prevail.

**No offer to sell or license** — Nothing in this document may be interpreted or construed as an offer to sell products that is open for acceptance or the grant, conveyance or implication of any license under any copyrights, patents or other industrial or intellectual property rights.

### 12.4 Trademarks

Notice: All referenced brands, product names, service names and trademarks are the property of their respective owners.

## 13. Contact information

For additional information, please visit: <http://www.nxp.com>

For sales office addresses, send an email to: [salesaddresses@nxp.com](mailto:salesaddresses@nxp.com)

**14. Contents**

**1 Product profile . . . . . 1**

1.1 General description . . . . . 1

1.2 Features . . . . . 1

1.3 Applications . . . . . 1

1.4 Quick reference data . . . . . 1

**2 Pinning information . . . . . 2**

**3 Ordering information . . . . . 2**

**4 Marking . . . . . 2**

**5 Limiting values . . . . . 2**

**6 Characteristics . . . . . 4**

**7 Application information . . . . . 7**

**8 Package outline . . . . . 8**

**9 Packing information . . . . . 8**

**10 Soldering . . . . . 9**

**11 Revision history . . . . . 10**

**12 Legal information . . . . . 11**

12.1 Data sheet status . . . . . 11

12.2 Definitions . . . . . 11

12.3 Disclaimers . . . . . 11

12.4 Trademarks . . . . . 11

**13 Contact information . . . . . 11**

**14 Contents . . . . . 12**

Please be aware that important notices concerning this document and the product(s) described herein, have been included in section 'Legal information'.



© NXP B.V. 2008.

All rights reserved.

For more information, please visit: <http://www.nxp.com>

For sales office addresses, please send an email to: [salesaddresses@nxp.com](mailto:salesaddresses@nxp.com)

Date of release: 15 February 2008

Document identifier: PESD1FLEX\_2

# Mouser Electronics

Authorized Distributor

Click to View Pricing, Inventory, Delivery & Lifecycle Information:

[NXP:](#)

[PESD1FLEX,215](#)