

Description

The SM30TY Transil series has been designed to protect automotive sensitive circuits against surges defined in ISO 7637-2 and against electrostatic discharges according to ISO 10605.

The planar technology makes it compatible with high-end circuits where low leakage current and high junction temperature are required to provide reliability and stability over time. SM30TY are packaged in SMC (SMC footprint in accordance with IPC 7531 standard).

Features

- Peak pulse power:
 - 3000 W (10/1000 μ s)
 - Up to 36 kW (8/20 μ s)
- Stand-off voltage range: from 5 V to 48 V
- Unidirectional and bidirectional types
- Operating Tj max: 175 °C
- JEDEC registered package outline
- Resin meets UL 94, V0
- AEC-Q101 qualified

Complies with the following standards

- ISO 10605 - C = 150 pF, R = 330 Ω exceeds level 4
 - 30 kV (air discharge)
 - 30 kV (contact discharge)
- ISO 10605 - C = 330 pF, R = 330 Ω exceeds level 4
 - 30 kV (air discharge)
 - 30 kV (contact discharge)
- ISO 7637-2:
 - Pulse 1: V_s = -150 V
 - Pulse 2a: V_s = +112 V
 - Pulse 3a: V_S = -220 V
 - Pulse 3b: V_S = +150 V

TM: Transil is a trademark of STMicroelectronics

1 Characteristics

Table 1. Absolute maximum ratings ($T_{amb} = 25\text{ }^{\circ}\text{C}$)

Symbol	Parameter		Value	Unit
V_{PP}	Peak pulse voltage	ISO10605 (C = 330 pF, R = 330 Ω)		
		contact discharge	30	kV
		air discharge	30	
		IEC 61000-4-2 /ISO10605 (C = 150 pF, R = 330 Ω)		
	contact discharge	30		
	air discharge	30		
P_{PP}	Peak pulse power dissipation	$T_{j\text{ initial}} = T_{amb}$	3000	W
T_{stg}	Storage temperature range		-65 to + 175	$^{\circ}\text{C}$
T_j	Operating junction temperature range		-55 to + 175	$^{\circ}\text{C}$
T_L	Maximum lead temperature for soldering during 10 s.		260	$^{\circ}\text{C}$

Figure 1. Electrical characteristics - definitions

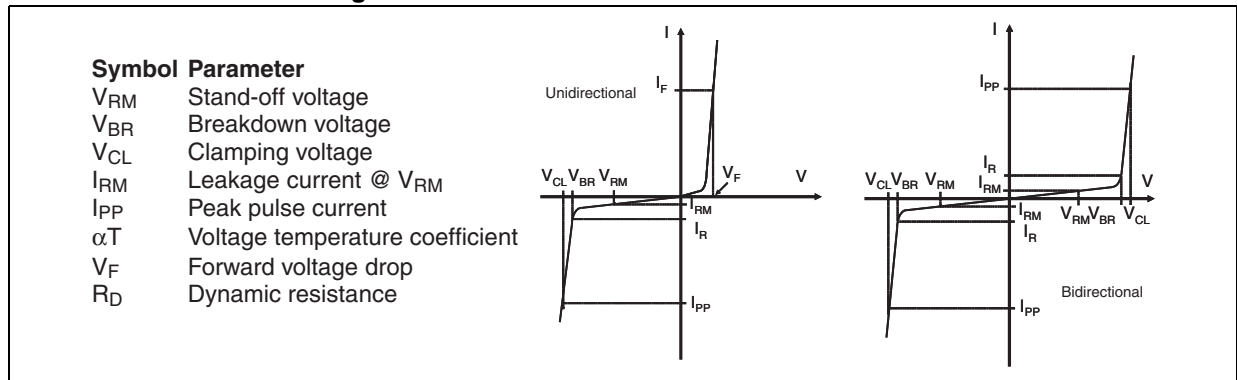

Figure 2. Pulse definition for electrical characteristics

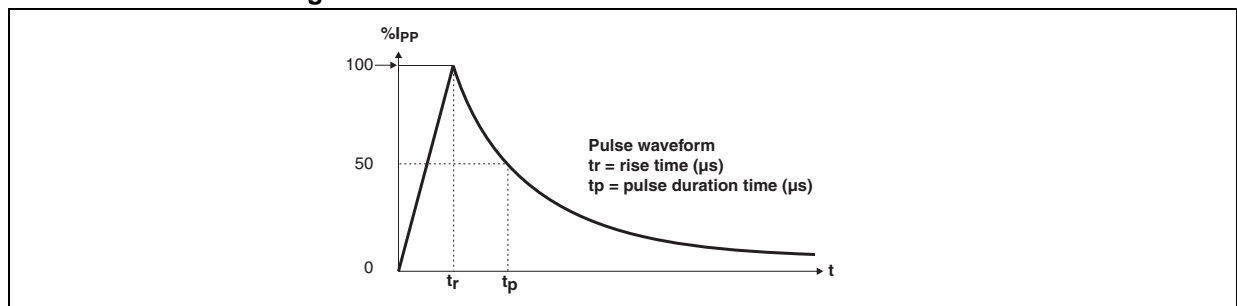

Table 2. Electrical characteristics, parameter values ($T_{amb} = 25\text{ °C}$)

Order code	I_{RM} max at V_{RM}		V_{BR} at $I_R^{(1)}$				V_{CL} at I_{PP} 10/1000 μs		R_D 10/1000 μs	V_{CL} at I_{PP} 8/20 μs		R_D 8/20 μs	$\alpha T^{(2)}$
			min	typ	max		max			max			max
	μA	V	V			mA	V ⁽³⁾	A ⁽⁴⁾	Ω	V ⁽³⁾	A ⁽⁴⁾	Ω	10-4/ $^{\circ}C$
SM30T6.8AY/CAY	500	5	6.45	6.80	7.10	10	9.20	327	0.007	13.4	1649	0.004	5.7
SM30T7.5AY/CAY	250	6.5	7.13	7.50	7.90	10	11.2	268	0.014	14.5	1604	0.004	6.1
SM30T10AY/CAY	10	8.5	9.50	10.0	10.5	1	14.4	208	0.021	19.5	1387	0.007	7.3
SM30T12AY/CAY	0.2	10	11.4	12.0	12.6	1	17.0	176	0.028	21.7	1170	0.008	7.8
SM30T15AY/CAY	0.2	13	14.3	15.0	15.8	1	21.5	140	0.046	27.2	993	0.012	8.4
SM30T18AY/CAY	0.2	15	16.7	17.6	18.5	1	24.4	123.0	0.055	32.5	926	0.016	8.8
SM30T19AY/CAY	0.2	16	17.8	18.7	19.6	1	26.0	115.4	0.063	34.4	868	0.018	8.8
SM30T21AY/CAY	0.2	18	20	21.1	22.2	1	29.2	102.7	0.079	39.3	800	0.023	9.2
SM30T23AY/CAY	0.2	20	22.2	23.4	24.6	1	32.4	92.6	0.097	42.8	747	0.026	9.4
SM30T26AY/CAY	0.2	22	24.4	25.7	27.0	1	35.5	84.5	0.116	48.3	701	0.032	9.6
SM30T28AY/CAY	0.2	24	26.7	28.1	29.5	1	38.9	77.1	0.140	50.0	660	0.033	9.6
SM30T30AY/CAY	0.2	26	28.9	30.4	31.9	1	42.1	71.3	0.164	53.5	626	0.037	9.7
SM30T33AY/CAY	0.2	28	31.1	32.7	34.3	1	45.4	66.1	0.192	59.0	596	0.044	9.8
SM30T35AY/CAY	0.2	30	33.3	35.1	36.9	1	48.4	62.0	0.215	64.3	569	0.051	9.9
SM30T39AY/CAY	0.2	33	36.7	38.6	40.5	1	53.3	56.3	0.261	69.7	526	0.059	10.0
SM30T42AY/CAY	0.2	36	40.0	42.1	44.2	1	58.1	48.4	0.331	76.0	503	0.067	10.0
SM30T47AY/CAY	0.2	40	44.4	46.7	49.0	1	64.5	43.5	0.409	84.0	469	0.079	10.1
SM30T56AY/CAY	0.2	48	53.2	56.0	58.8	1	76.6	38.0	0.542	100	409	0.108	10.3

1. Pulse test: $t_p < 50\text{ ms}$

2. To calculate V_{BR} or V_{CL} versus junction temperature, use the following formulas:

$$V_{BR} \text{ at } T_J = V_{BR} \text{ at } 25\text{ °C} \times (1 + \alpha T \times (T_J - 25))$$

$$V_{CL} \text{ at } T_J = V_{CL} \text{ at } 25\text{ °C} \times (1 + \alpha T \times (T_J - 25))$$

3. To calculate maximum clamping voltage at other surge level, use the following formula:
 $V_{CL} \text{ max} = V_{CL} - R_D \times (I_{PP} - I_{PP\text{appli}})$ where $I_{PP\text{appli}}$ is the surge current in the application.

4. Surge capability given for both directions for unidirectional and bidirectional types.

Figure 3. Peak pulse power dissipation versus initial junction temperature

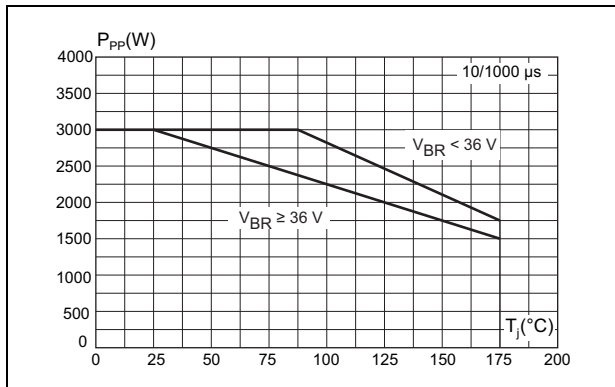

Figure 4. Peak pulse power versus exponential pulse duration (T_j initial = 25 °C)

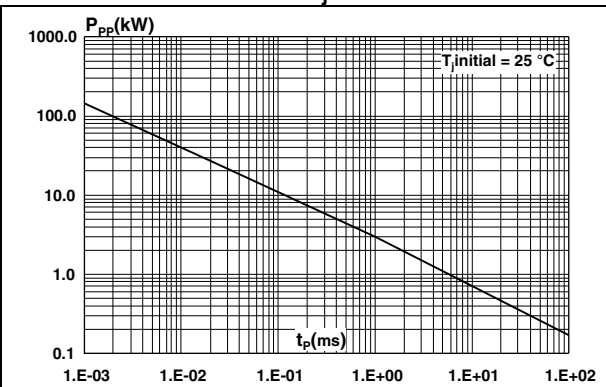

Figure 5. Clamping voltage versus peak pulse current (exponential waveform, maximum values)

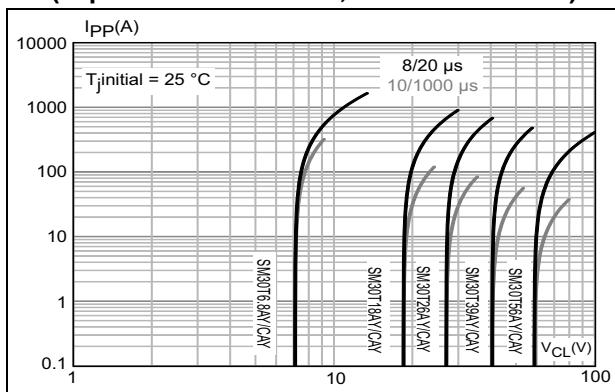

Figure 6. Junction capacitance versus reverse applied voltage for unidirectional types

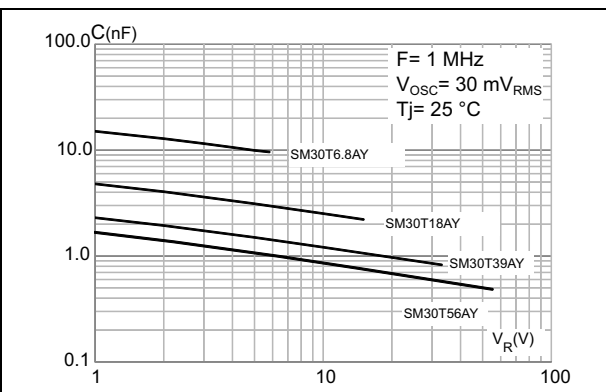

Figure 7. Junction capacitance versus reverse applied voltage for bidirectional types

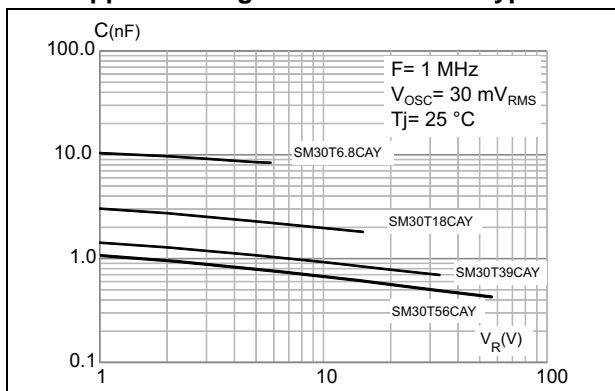

Figure 8. Leakage current versus junction temperature

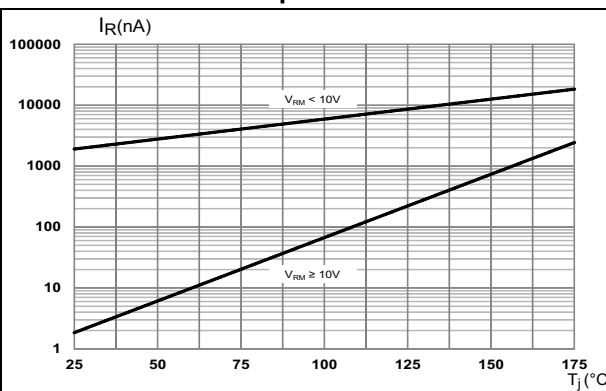

Figure 9. Peak forward voltage drop versus peak forward current

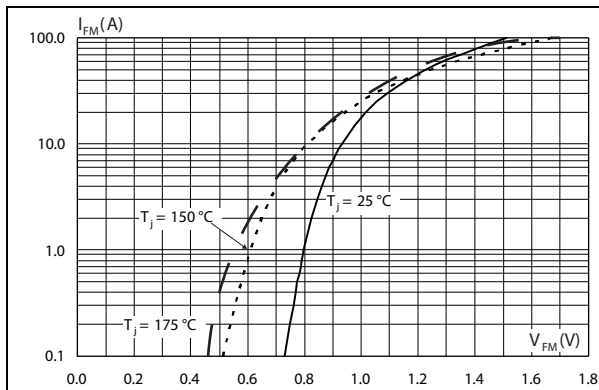

Figure 10. Relative variation of thermal impedance junction to ambient versus pulse duration

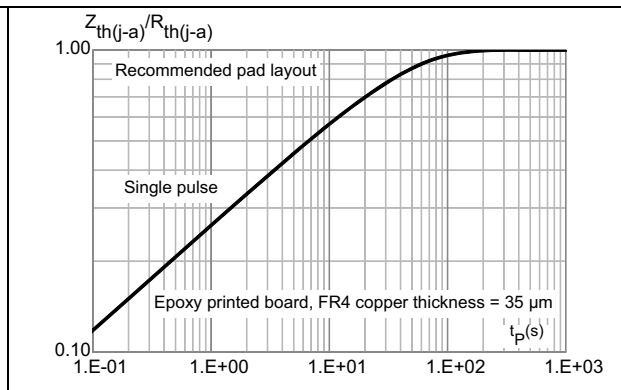

Figure 11. Thermal resistance junction to ambient versus copper surface under each lead

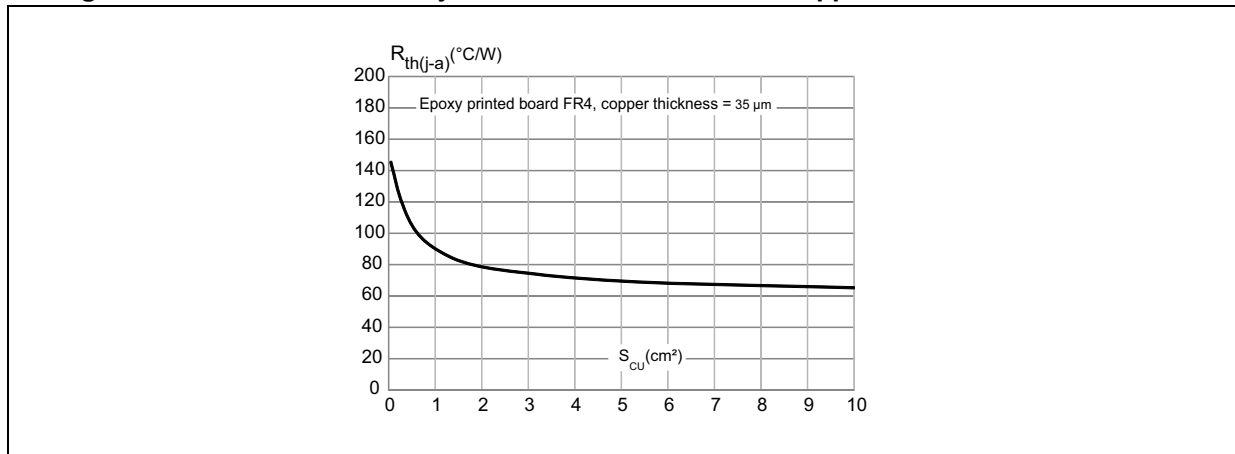

Figure 12. ISO7637-2 pulse 1 response ($V_S = -150\text{ V}$)

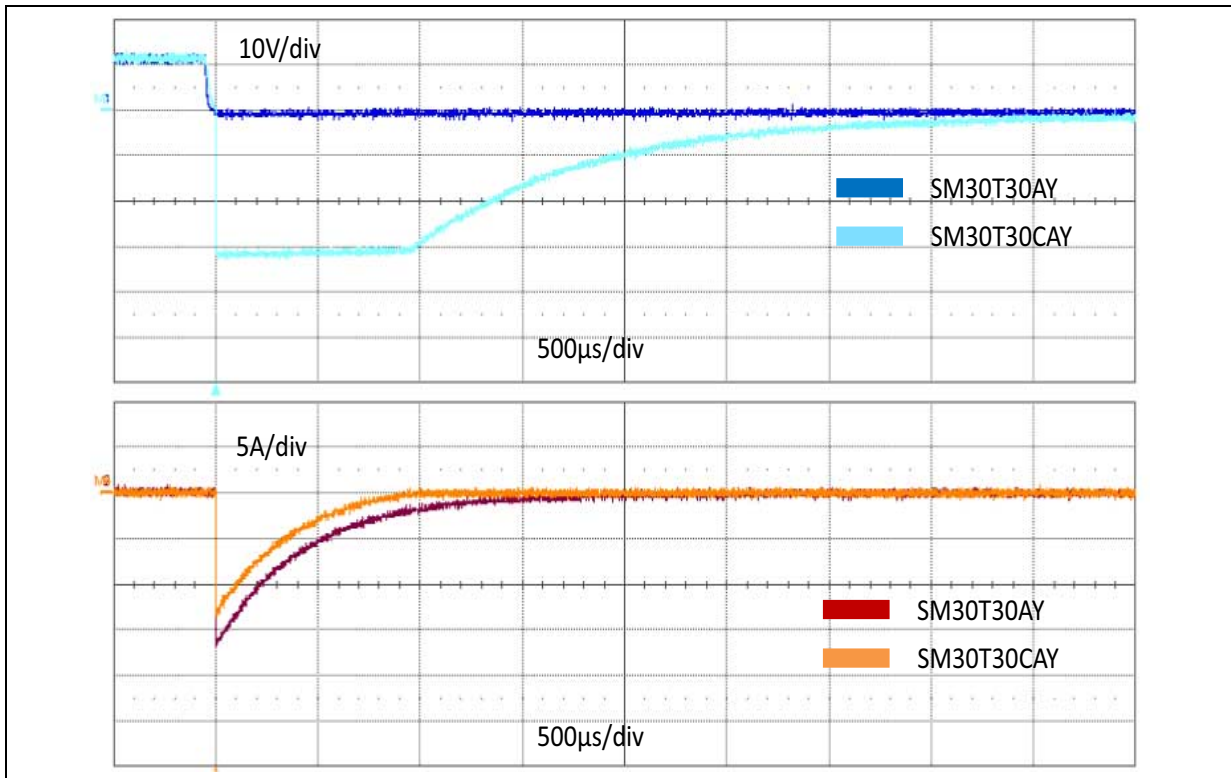

Figure 13. ISO7637-2 pulse 2a response ($V_S = 112\text{ V}$)

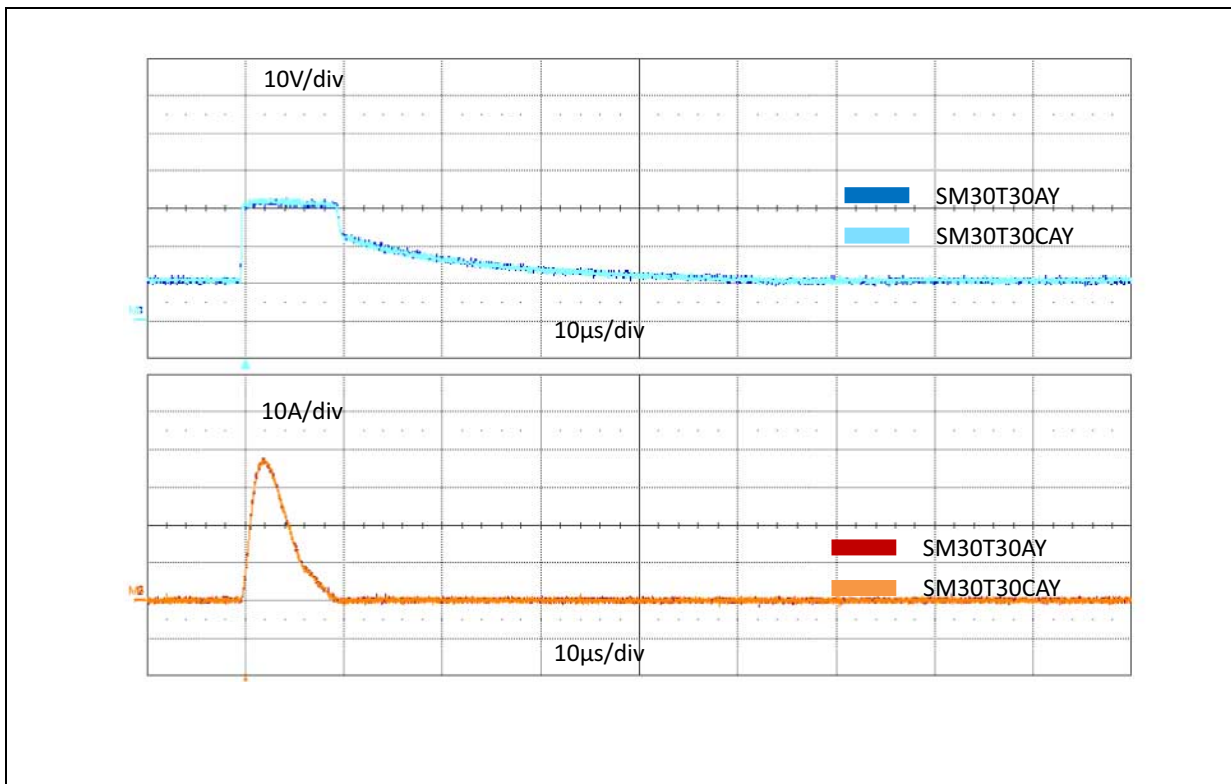

Figure 14. ISO7637-2 pulse 3a response ($V_S = -220\text{ V}$)

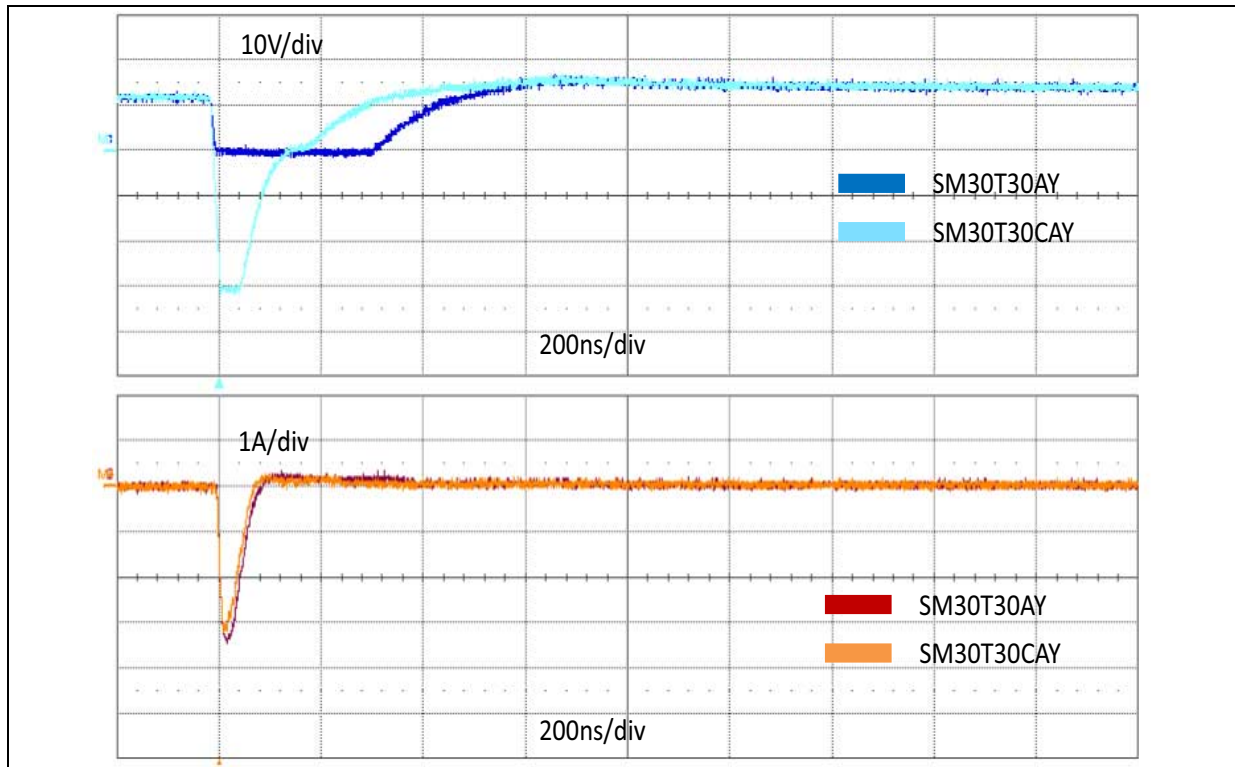
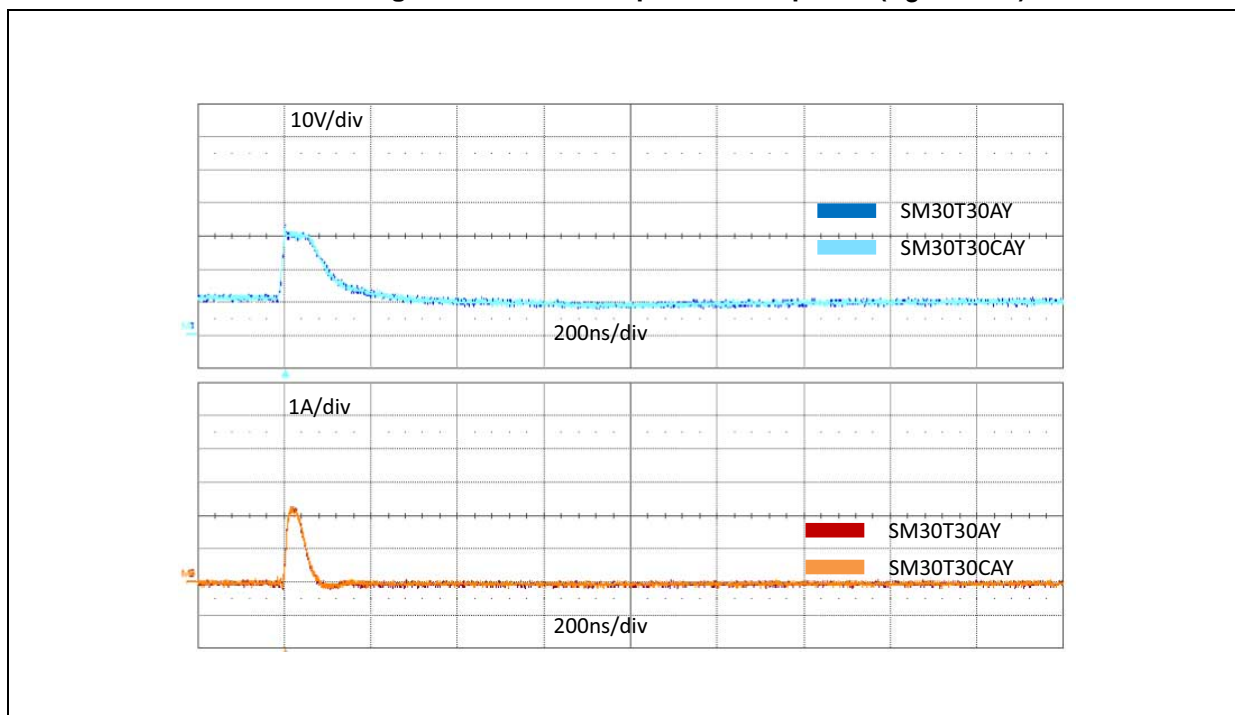

Figure 15. ISO7637-2 pulse 3b response ($V_S = 150\text{ V}$)



Note: ISO7637-2 pulses responses are not applicable for product with a stand-off voltage lower than the average battery voltage (13.5 V).

Figure 16. ISO7637-2 pulse 5b definition

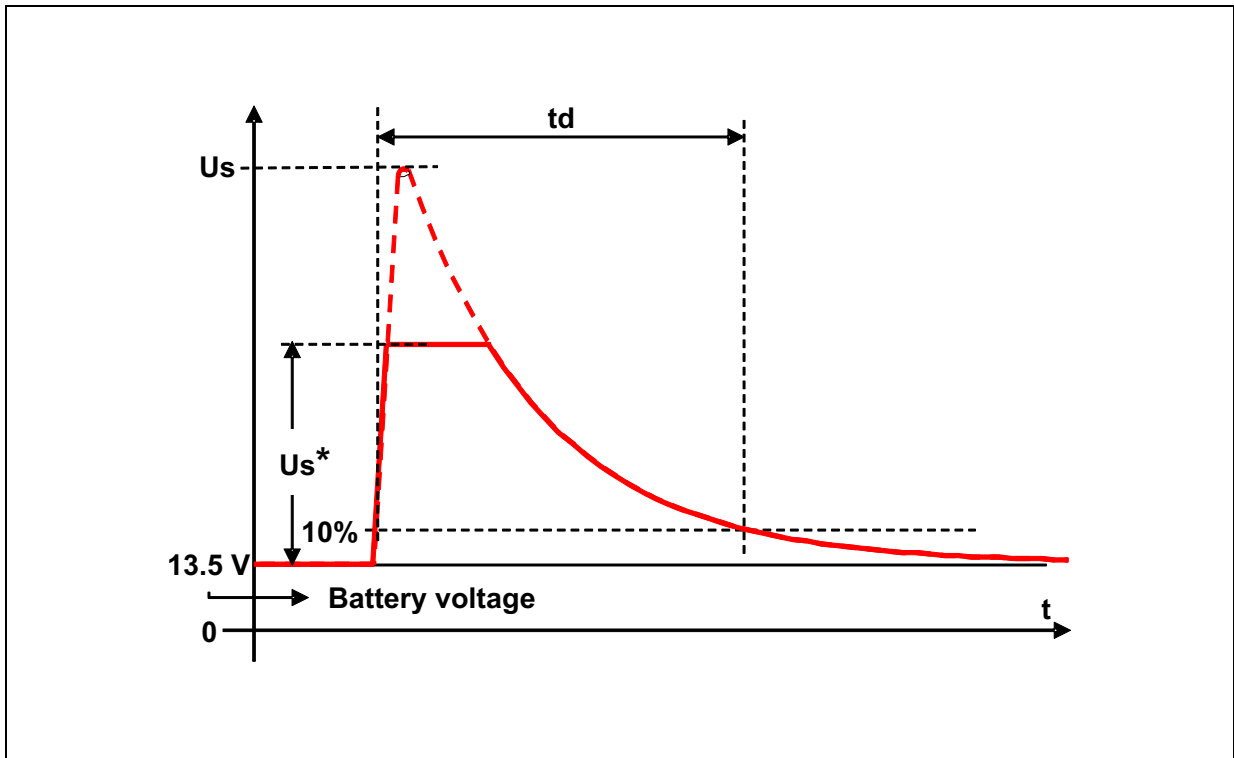

Figure 17. Load dump capability (typical values, $U_s^* = f(R_i)$ pulse 5b, $U_s = 87\text{ V}$, $t_p = 150\text{ ms}$)

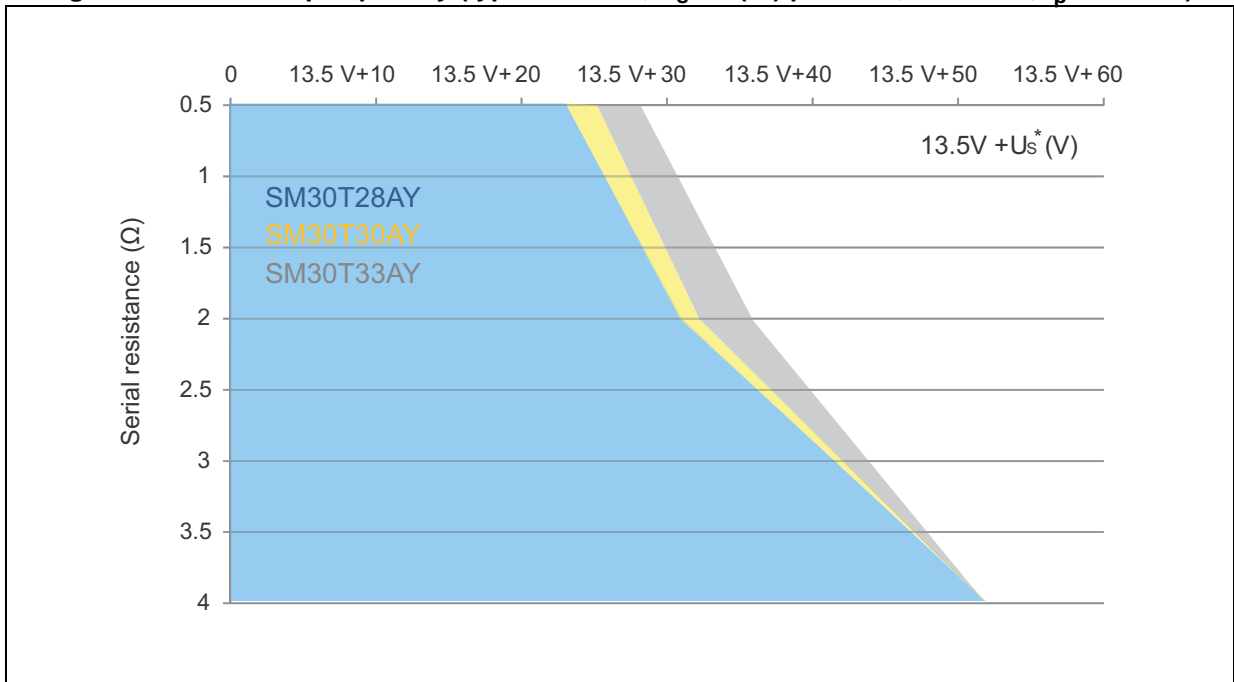

Figure 18. Load dump capability (typical values, $U_s^* = f(R_i)$ pulse 5b, $U_s = 87\text{ V}$, $t_p = 400\text{ ms}$)

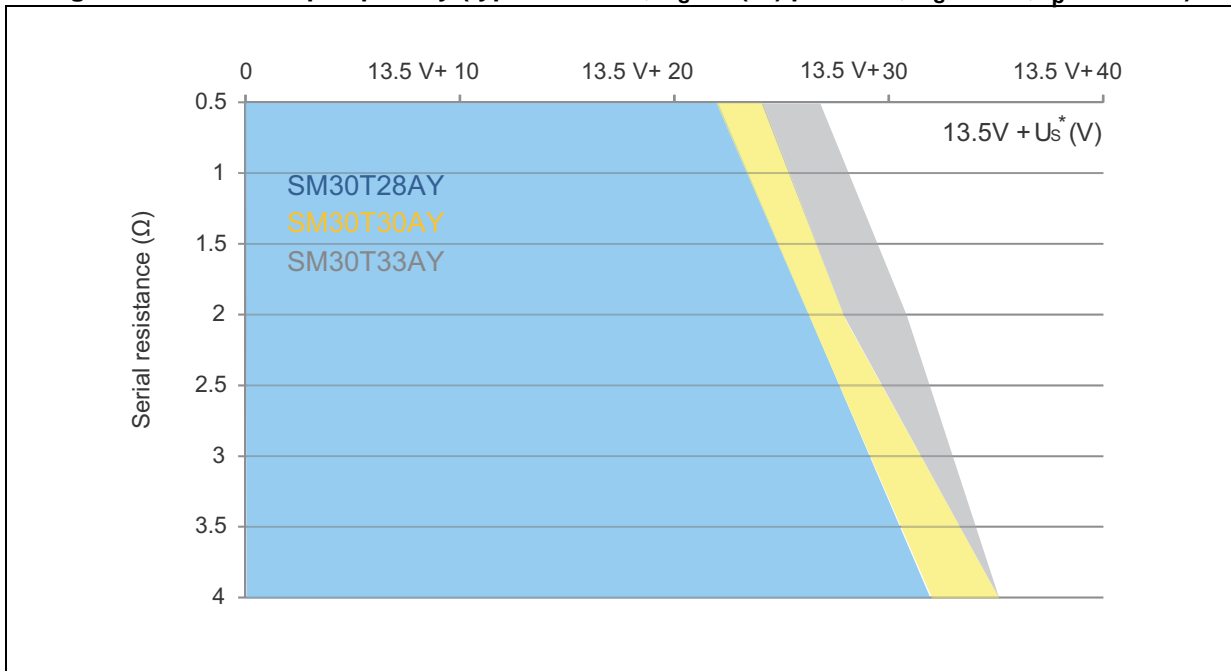

Figure 19. ISO16750-2 test B definition

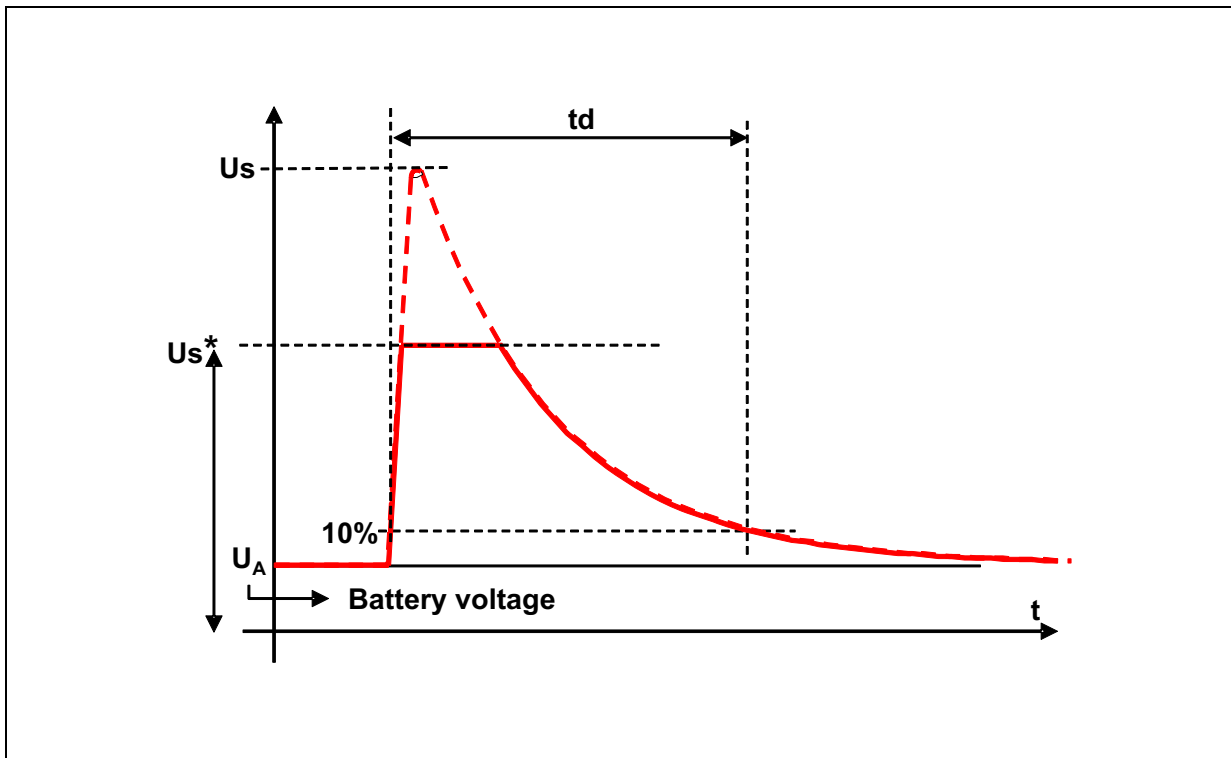

Figure 20. Load dump capability (typical values, $U_s^* = f(R_i)$ test B, $U_s = 87\text{ V}$, $t_p = 150\text{ ms}$)

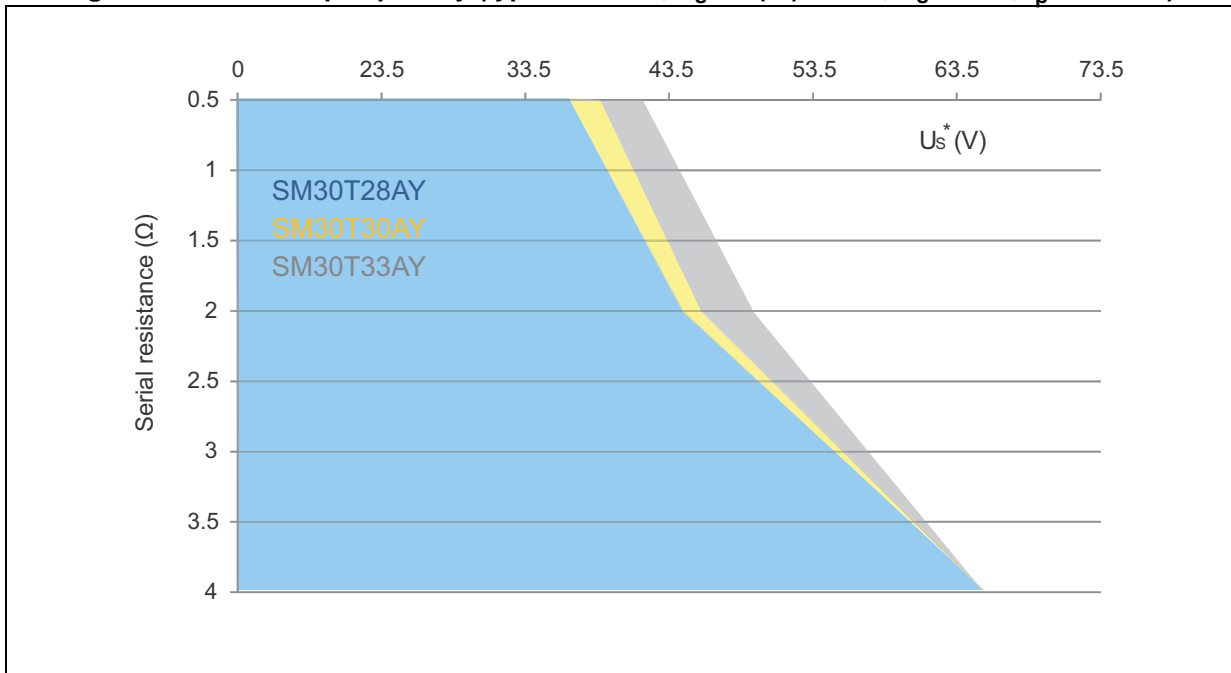
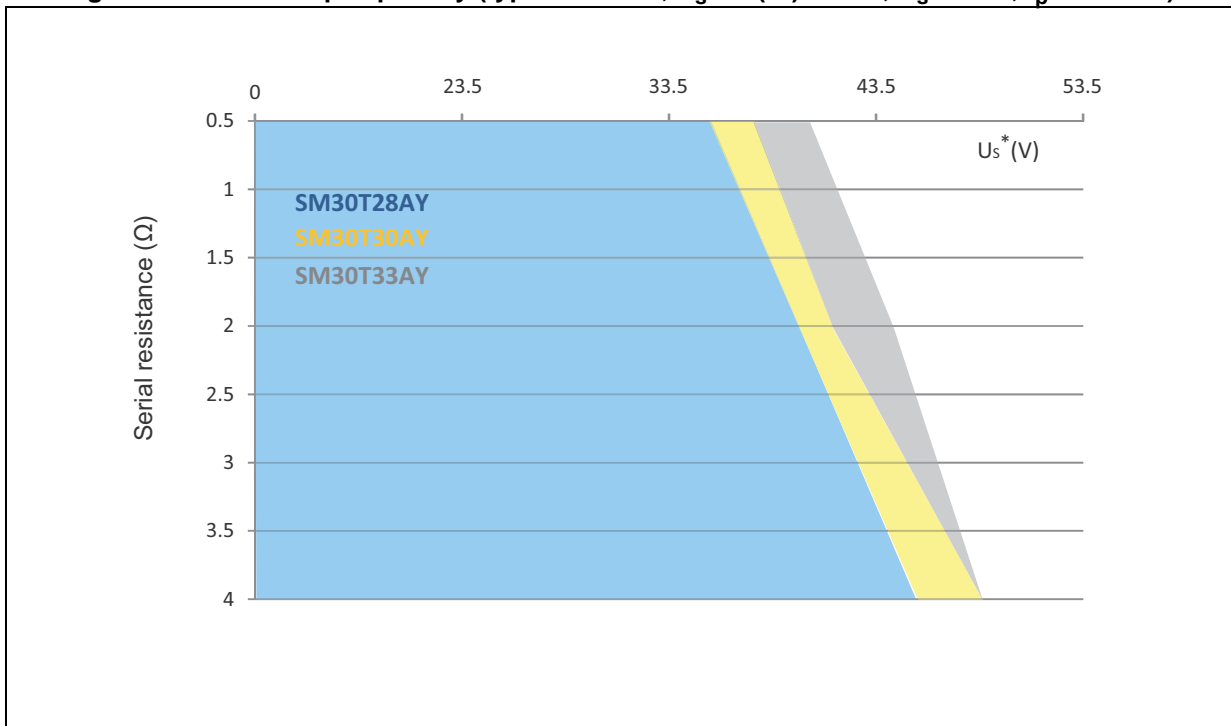

Figure 21. Load dump capability (typical values, $U_s^* = f(R_i)$ test B, $U_s = 87\text{ V}$, $t_p = 400\text{ ms}$)



2 Application and design guidelines

More information is available in the Application note AN2689 "Protection of automotive electronics from electrical hazards, guidelines for design and component selection".

3 Package information

- Case: JEDEC DO-214AB molded plastic over planar junction
- Terminals: solder plated, solderable as per MIL-STD-750, Method 2026
- Polarity: for unidirectional types the band indicates cathode
- Flammability: epoxy is rated UL 94, V0
- RoHS package

In order to meet environmental requirements, ST offers these devices in different grades of ECOPACK® packages, depending on their level of environmental compliance. ECOPACK® specifications, grade definitions and product status are available at: www.st.com. ECOPACK® is an ST trademark.

Figure 22. SMC dimension definitions

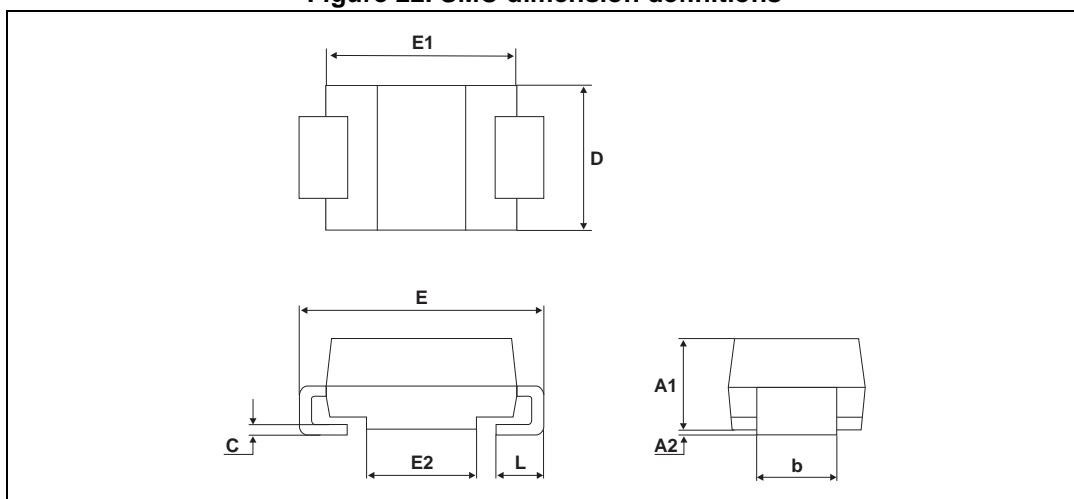

Table 3. SMC dimension values

Ref.	Dimensions			
	Millimeters		Inches	
	Min.	Max.	Min.	Max.
A1	1.90	2.45	0.075	0.096
A2	0.05	0.20	0.002	0.008
b	2.90	3.20	0.114	0.126
c	0.15	0.40	0.006	0.016
D	5.55	6.25	0.218	0.246
E	7.75	8.15	0.305	0.321
E1	6.60	7.15	0.260	0.281
E2	4.40	4.70	0.173	0.185
L	0.75	1.50	0.030	0.059

Figure 23. SMC footprint dimensions in mm (inches)

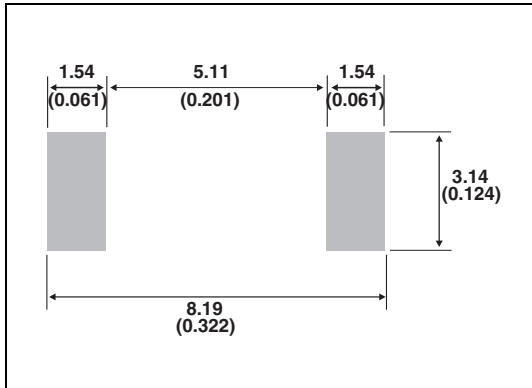
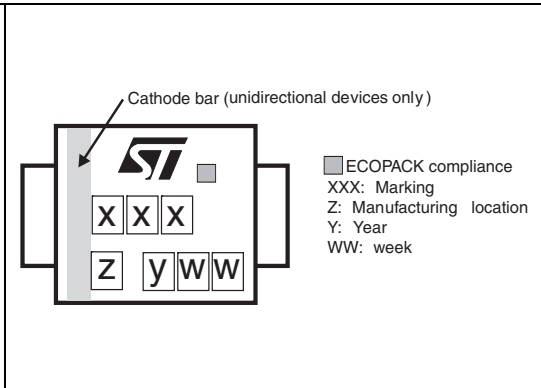

Figure 24. Marking layout⁽¹⁾



1. Marking layout can vary according to assembly location.

Table 4. Marking

Order code	Marking	Order code	Marking
SM30T6.8AY	3AAAY	SM30T6.8CAY	3BAAY
SM30T7.5AY	3AACY	SM30T7.5CAY	3BACY
SM30T10AY	3AADY	SM30T10CAY	3BADY
SM30T12AY	3AAWY	SM30T12CAY	3BAWY
SM30T15AY	3AAGY	SM30T15CAY	3BAGY
SM30T18AY	3AAHY	SM30T18CAY	3BAHY
SM30T19AY	3AAIY	SM30T19CAY	3BAIY
SM30T21AY	3AAJY	SM30T21CAY	3BAJY
SM30T23AY	3AAKY	SM30T23CAY	3BAKY
SM30T26AY	3AALY	SM30T26CAY	3BALY
SM30T28AY	3AAEY	SM30T28CAY	3BAEY
SM30T30AY	3AAMY	SM30T30CAY	3BAMY
SM30T33AY	3AANY	SM30T33CAY	3BANY
SM30T35AY	3AAOY	SM30T35CAY	3BAOY
SM30T39AY	3AAPY	SM30T39CAY	3BAPY
SM30T42AY	3AAQY	SM30T42CAY	3BAQY
SM30T47AY	3AARY	SM30T47CAY	3BARY
SM30T56AY	3AASY	SM30T56CAY	3BAS Y

4 Ordering information

Figure 25. Ordering information scheme

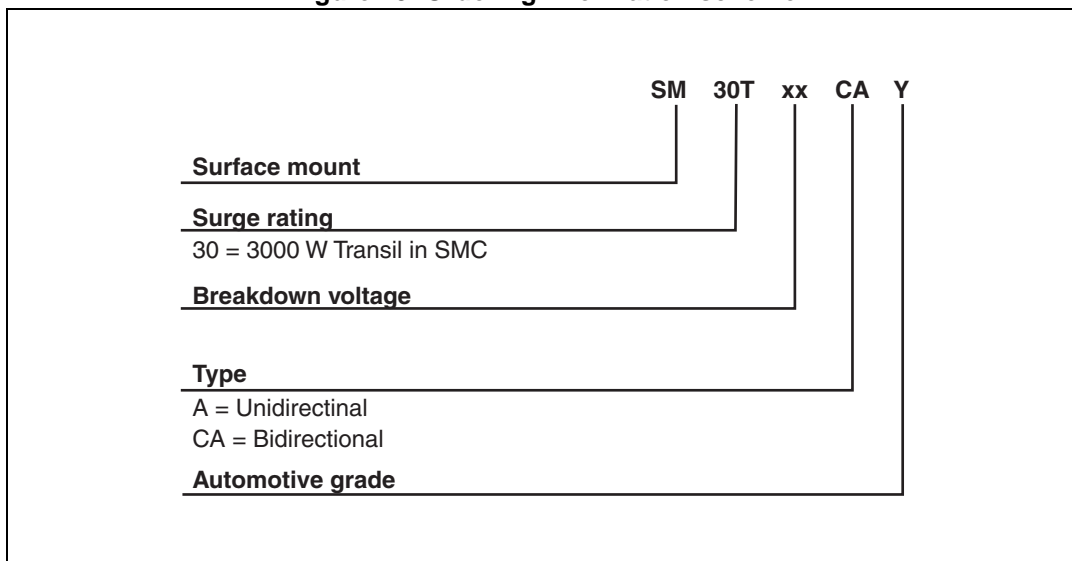

Table 5. Ordering information

Order code	Marking	Package	Weight	Base qty	Delivery mode
SM30TxxAY/CAY ⁽¹⁾	See Table 4 on page 13	SMC	0.25 g	2500	Tape and reel

1. Where xxx is nominal value of V_{BR} and A or CA indicates unidirectional or bidirectional version. See [Table 2](#) for list of available devices and their order codes

5 Revision history

Table 6. Document revision history

Date	Revision	Changes
28-Jul-2011	1	Initial release.
27-Mar-2012	2	Updated footnote on page 1. Removed Table 2. Thermal parameter.
02-Jun-2014	3	Updated : <i>Features</i> , <i>Table 2</i> , <i>Table 4</i> and reformatted to current standard.
09-Jan-2015	4	Updated <i>Features</i> , <i>Table 2</i> , <i>Table 4</i> , <i>Figure 5</i> to <i>Figure 8</i> and <i>Figure 11</i> to <i>Figure 21</i> .
13-Jul-2015	5	Updated features in cover page, <i>Table 1</i> , <i>Table 2</i> and <i>Table 4</i> . Updated <i>Figure 3</i> , <i>Figure 5</i> , <i>Figure 6</i> , <i>Figure 7</i> , <i>Figure 8</i> , <i>Figure 9</i> , <i>Figure 11</i> , <i>Figure 12</i> , <i>Figure 13</i> , <i>Figure 14</i> , <i>Figure 15</i> , <i>Figure 17</i> , <i>Figure 18</i> , <i>Figure 20</i> and <i>Figure 21</i> .
27-Jul-2015	6	Updated <i>Figure 10</i> and <i>Figure 15</i> .

IMPORTANT NOTICE – PLEASE READ CAREFULLY

STMicroelectronics NV and its subsidiaries (“ST”) reserve the right to make changes, corrections, enhancements, modifications, and improvements to ST products and/or to this document at any time without notice. Purchasers should obtain the latest relevant information on ST products before placing orders. ST products are sold pursuant to ST’s terms and conditions of sale in place at the time of order acknowledgement.

Purchasers are solely responsible for the choice, selection, and use of ST products and ST assumes no liability for application assistance or the design of Purchasers’ products.

No license, express or implied, to any intellectual property right is granted by ST herein.

Resale of ST products with provisions different from the information set forth herein shall void any warranty granted by ST for such product.

ST and the ST logo are trademarks of ST. All other product or service names are the property of their respective owners.

Information in this document supersedes and replaces information previously supplied in any prior versions of this document.

© 2015 STMicroelectronics – All rights reserved

Mouser Electronics

Authorized Distributor

Click to View Pricing, Inventory, Delivery & Lifecycle Information:

STMicroelectronics:

[SM30T18AY](#) [SM30T18CAY](#) [SM30T19AY](#) [SM30T19CAY](#) [SM30T21AY](#) [SM30T21CAY](#) [SM30T23AY](#) [SM30T23CAY](#)
[SM30T26AY](#) [SM30T26CAY](#) [SM30T28AY](#) [SM30T28CAY](#) [SM30T30AY](#) [SM30T33AY](#) [SM30T33CAY](#) [SM30T35AY](#)
[SM30T35CAY](#) [SM30T39AY](#) [SM30T39CAY](#) [SM30T30CAY](#) [SM30T10AY](#) [SM30T10CAY](#) [SM30T12AY](#) [SM30T12CAY](#)
[SM30T15AY](#) [SM30T15CAY](#) [SM30T6.8AY](#) [SM30T6.8CAY](#) [SM30T7.5AY](#) [SM30T7.5CAY](#)