

Surface Mount TRANSZORB[®] Transient Voltage Suppressors

DO-214AB (SMC)

PRIMARY CHARACTERISTICS	
V_{WM}	5.8 V to 459 V
V_{BR} (uni-directional)	6.8 V to 540 V
V_{BR} (bi-directional)	6.8 V to 220 V
P_{PPM}	1500 W
P_D	6.5 W
I_{FSM} (uni-directional only)	200 A
T_J max.	150 °C
Polarity	Uni-directional, bi-directional
Package	DO-214AB (SMC)

DEVICES FOR BI-DIRECTION APPLICATIONS

For bi-directional devices use CA suffix (e.g. 1.5SMC220CA).

Electrical characteristics apply in both directions.

FEATURES

- Low profile package
- Ideal for automated placement
- Glass passivated chip junction
- Available in uni-directional and bi-directional
- 1500 W peak pulse power capability with a 10/1000 μ s waveform, repetitive rate (duty cycle): 0.01 %
- Excellent clamping capability
- Very fast response time
- Low incremental surge resistance
- Meets MSL level 1, per J-STD-020, LF maximum peak of 260 °C
- AEC-Q101 qualified
- Material categorization: For definitions of compliance please see www.vishay.com/doc?99912

RoHS
COMPLIANT

TYPICAL APPLICATIONS

Use in sensitive electronics protection against voltage transients induced by inductive load switching and lighting on ICs, MOSFET, signal lines of sensor units for consumer, computer, industrial, automotive, and telecommunication.

MECHANICAL DATA

Case: DO-214AB (SMC)

Molding compound meets UL 94 V-0 flammability rating
 Base P/N-E3 - RoHS compliant and commercial grade
 Base P/NHE3 - RoHS compliant and AEC-Q101 qualified
 Base P/NHE3_X - RoHS-compliant and AEC-Q101 qualified ("X" denotes revision code e.g. A, B,)

Terminals: Matte tin plated leads, solderable per J-STD-002 and JESD 22-B102

E3 suffix meets JESD 201 class 1A whisker test, HE3 suffix meets JESD 201 class 2 whisker test

Polarity: For uni-directional types the band denotes cathode end, no marking on bi-directional types

MAXIMUM RATINGS ($T_A = 25$ °C unless otherwise noted)			
PARAMETER	SYMBOL	VALUE	UNIT
Peak power dissipation with a 10/1000 μ s waveform ⁽¹⁾⁽²⁾ (fig. 1)	P_{PPM}	1500	W
Peak pulse current with a 10/1000 μ s waveform ⁽¹⁾ (fig. 3)	I_{PPM}	See next table	A
Power dissipation on infinite heatsink at $T_A = 50$ °C	P_D	6.5	W
Peak forward surge current 8.3 ms single half sine-wave uni-directional only ⁽²⁾	I_{FSM}	200	A
Operating junction and storage temperature range	T_J, T_{STG}	- 65 to + 150	°C

Notes

⁽¹⁾ Non-repetitive current pulse, per fig. 3 and derated above $T_A = 25$ °C per fig. 2.

⁽²⁾ Mounted on 0.31" x 0.31" (8.0 mm x 8.0 mm) copper pads to each terminal



ELECTRICAL CHARACTERISTICS (T _A = 25 °C unless otherwise noted)										
PART NUMBER	DEVICE MARKING CODE		BREAKDOWN VOLTAGE V _{BR} AT I _T (1) (V)		TEST CURRENT I _T (mA)	STAND-OFF VOLTAGE V _{WM} (V)	MAXIMUM REVERSE LEAKAGE AT V _{WM} I _D (4) (µA)	MAXIMUM PEAK PULSE CURRENT I _{PPM} (2) (A)	MAXIMUM CLAMPING VOLTAGE AT I _{PPM} V _C (V)	MAXIMUM TEMPERATURE COEFFICIENT OF V _{BR} (%/°C)
	UNI	BI	MIN.	MAX.						
1.5SMC6.8A	6V8A	6V8C	6.45	7.14	10	5.80	1000	143	10.5	0.057
1.5SMC7.5A	7V5A	7V5C	7.13	7.88	10	6.40	500	133	11.3	0.061
1.5SMC8.2A	8V2A	8V2C	7.79	8.61	10	7.02	200	124	12.1	0.065
1.5SMC9.1A	9V1A	9V1C	8.65	9.55	1.0	7.78	50	112	13.4	0.068
1.5SMC10A	10A	10C	9.50	10.5	1.0	8.55	10	103	14.5	0.073
1.5SMC11A	11A	11C	10.5	11.6	1.0	9.40	5.0	96.2	15.6	0.075
1.5SMC12A	12A	12C	11.4	12.6	1.0	10.2	5.0	89.8	16.7	0.078
1.5SMC13A	13A	13C	12.4	13.7	1.0	11.1	5.0	82.4	18.2	0.081
1.5SMC15A	15A	15C	14.3	15.8	1.0	12.8	1.0	70.8	21.2	0.084
1.5SMC16A	16A	16C	15.2	16.8	1.0	13.6	1.0	66.7	22.5	0.086
1.5SMC18A	18A	18C	17.1	18.9	1.0	15.3	1.0	59.5	25.2	0.089
1.5SMC20A	20A	20C	19.0	21.0	1.0	17.1	1.0	54.2	27.7	0.090
1.5SMC22A	22A	22C	20.9	23.1	1.0	18.8	1.0	49.0	30.6	0.092
1.5SMC24A	24A	24C	22.8	25.2	1.0	20.5	1.0	45.2	33.2	0.090
1.5SMC27A	27A	27C	25.7	28.4	1.0	23.1	1.0	40.0	37.5	0.096
1.5SMC30A	30A	30C	28.5	31.5	1.0	25.6	1.0	36.2	41.4	0.097
1.5SMC33A	33A	33C	31.4	34.7	1.0	28.2	1.0	32.8	45.7	0.098
1.5SMC36A	36A	36C	34.2	37.8	1.0	30.8	1.0	30.1	49.9	0.099
1.5SMC39A	39A	39C	37.1	41.0	1.0	33.3	1.0	27.8	53.9	0.100
1.5SMC43A	43A	43C	40.9	45.2	1.0	36.8	1.0	25.3	59.3	0.101
1.5SMC47A	47A	47C	44.7	49.4	1.0	40.2	1.0	23.1	64.8	0.101
1.5SMC51A	51A	51C	48.5	53.6	1.0	43.6	1.0	21.4	70.1	0.102
1.5SMC56A	56A	56C	53.2	58.8	1.0	47.8	1.0	19.5	77.0	0.103
1.5SMC62A	62A	62C	58.9	65.1	1.0	53.0	1.0	17.6	85.0	0.104
1.5SMC68A	68A	68C	64.6	71.4	1.0	58.1	1.0	16.3	92.0	0.104
1.5SMC75A	75A	75C	71.3	78.8	1.0	64.1	1.0	14.6	104	0.105
1.5SMC82A	82A	82C	77.9	86.1	1.0	70.1	1.0	13.3	113	0.105
1.5SMC91A	91A	91C	86.5	95.5	1.0	77.8	1.0	12.0	125	0.106
1.5SMC100A	100A	100C	95.0	105	1.0	85.5	1.0	10.9	137	0.106
1.5SMC110A	110A	110C	105	116	1.0	94.0	1.0	9.9	152	0.107
1.5SMC120A	120A	120C	114	126	1.0	102	1.0	9.1	165	0.107
1.5SMC130A	130A	130C	124	137	1.0	111	1.0	8.4	179	0.107
1.5SMC150A	150A	150C	143	158	1.0	128	1.0	7.2	207	0.106
1.5SMC160A	160A	160C	152	168	1.0	136	1.0	6.8	219	0.108
1.5SMC170A	170A	170C	162	179	1.0	145	1.0	6.4	234	0.108
1.5SMC180A	180A	180C	171	189	1.0	154	1.0	6.1	246	0.108
1.5SMC200A	200A	200C	190	210	1.0	171	1.0	5.5	274	0.108
1.5SMC220A	220A	220C	209	231	1.0	185	1.0	4.6	328	0.108
1.5SMC250A	250A	-	237	263	1.0	214	1.0	4.4	344	0.110
1.5SMC300A	300A	-	285	315	1.0	256	1.0	3.6	414	0.110
1.5SMC350A	350A	-	333	368	1.0	300	1.0	3.1	482	0.110
1.5SMC400A	400A	-	380	420	1.0	342	1.0	2.7	548	0.110
1.5SMC440A	440A	-	418	462	1.0	376	1.0	2.5	602	0.110
1.5SMC480A	480A	-	456	504	1.0	408	1.0	2.28	658	0.110
1.5SMC510A	510A	-	485	535	1.0	434	1.0	2.15	698	0.110
1.5SMC540A	540A	-	513	567	1.0	459	1.0	2.03	740	0.110

Notes

- (1) Pulse test: t_p ≤ 50 ms
- (2) Surge current waveform per fig. 3 and derate per fig. 2
- (3) All terms and symbols are consistent with ANSI/IEEE CA62.35
- (4) For bi-directional types with V_R of 10 V and less, the I_D limit is doubled
- (5) V_F = 3.5 V at I_F = 100 A (uni-directional only)

THERMAL CHARACTERISTICS ($T_A = 25\text{ }^\circ\text{C}$ unless otherwise noted)			
PARAMETER	SYMBOL	VALUE	UNIT
Typical thermal resistance, junction to ambient air ⁽¹⁾	$R_{\theta JA}$	75	$^\circ\text{C/W}$
Typical thermal resistance, junction to leads	$R_{\theta JL}$	15	

Note

⁽¹⁾ Mounted on minimum recommended pad layout

ORDERING INFORMATION (Example)						
PREFERRED P/N	UNIT WEIGHT (g)	VOLTAGE RANGE (V)		PACKAGE CODE	BASE QUANTITY	DELIVERY MODE
		UNI -	BI -			
1.5SMC6.8A-E3/57T	0.211	6.8 to 540	6.8 to 220	57T	850	7" diameter plastic tape and reel
1.5SMC6.8A-E3/9AT	0.211	6.8 to 540	6.8 to 220	9AT	3500	13" diameter plastic tape and reel
1.5SMC6.8AHE3/57T ⁽¹⁾	0.211	6.8 to 540	6.8 to 220	57T	850	7" diameter plastic tape and reel
1.5SMC6.8AHE3/9AT ⁽¹⁾	0.211	6.8 to 540	6.8 to 220	9AT	3500	13" diameter plastic tape and reel
1.5SMC250AHE3_A/H ⁽¹⁾	0.211	250 to 540	-	H	850	7" diameter plastic tape and reel
1.5SMC250AHE3_A/I ⁽¹⁾	0.211	250 to 540	-	I	3500	13" diameter plastic tape and reel

Note

⁽¹⁾ AEC-Q101 qualified

RATINGS AND CHARACTERISTICS CURVES ($T_A = 25\text{ }^\circ\text{C}$ unless otherwise noted)

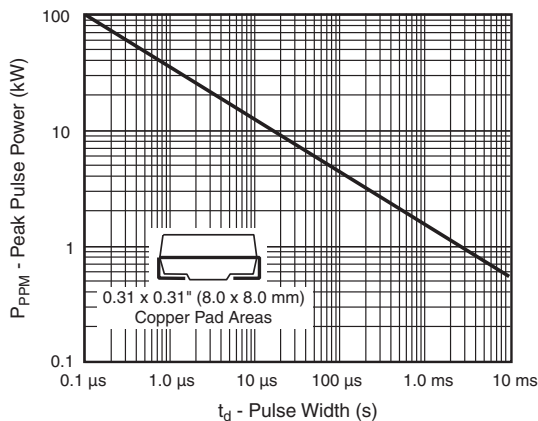

Fig. 1 - Peak Pulse Power Rating Curve

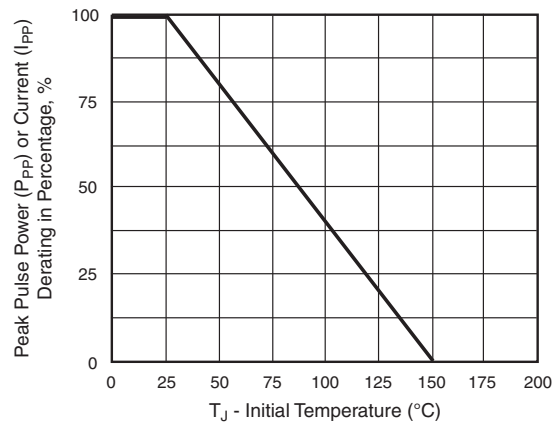

Fig. 2 - Pulse Power or Current vs. Initial Junction Temperature

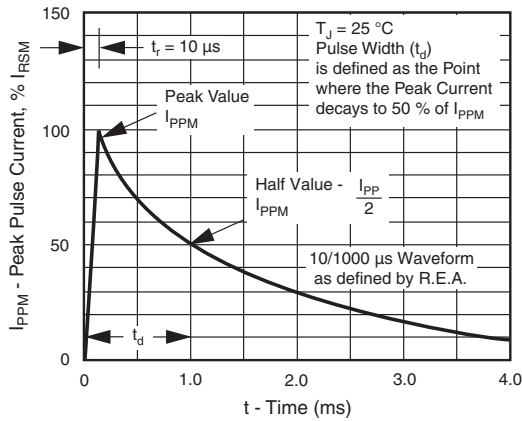

Fig. 3 - Pulse Waveform

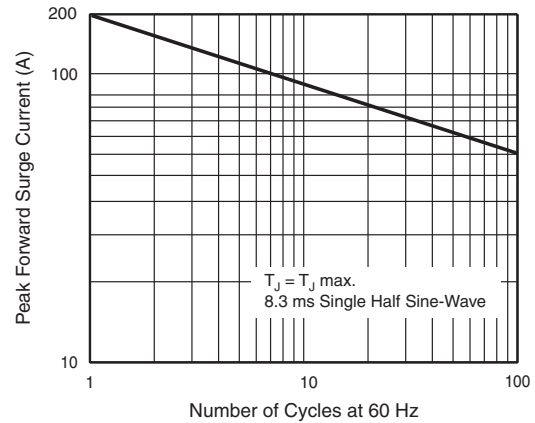

Fig. 6 - Maximum Non-Repetitive Forward Surge Current
Uni-Directional Use Only

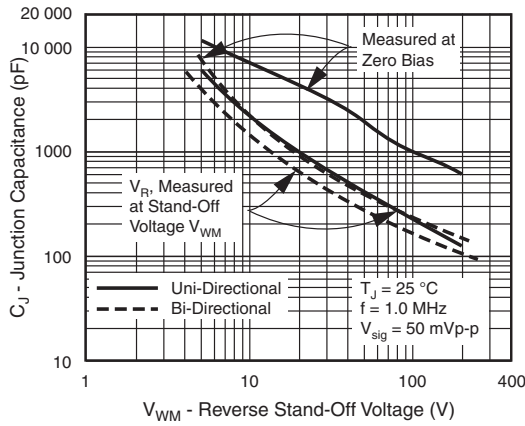

Fig. 4 - Typical Junction Capacitance Uni-Directional

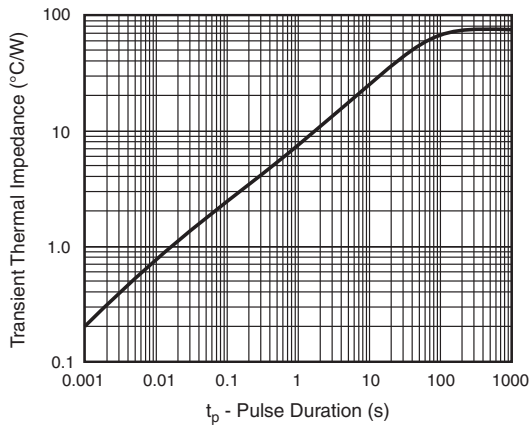
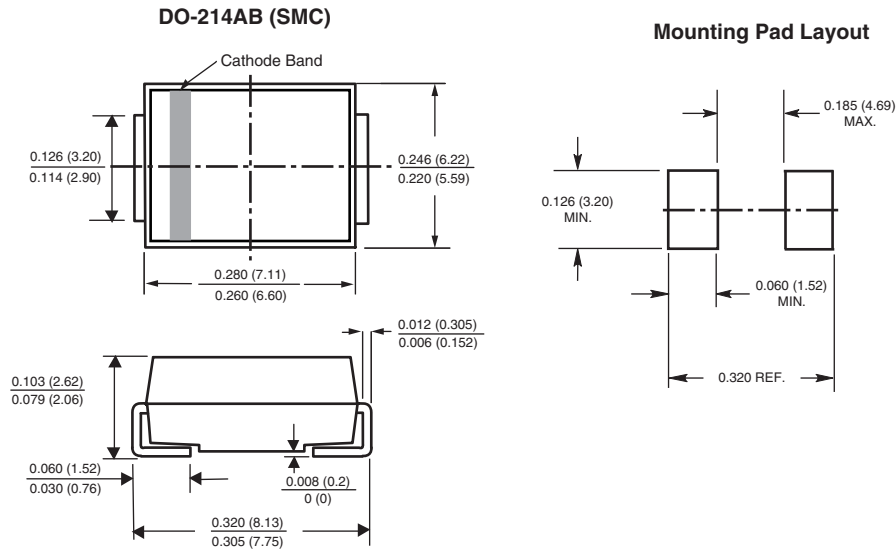

Fig. 5 - Typical Transient Thermal Impedance



PACKAGE OUTLINE DIMENSIONS in inches (millimeters)





Disclaimer

ALL PRODUCT, PRODUCT SPECIFICATIONS AND DATA ARE SUBJECT TO CHANGE WITHOUT NOTICE TO IMPROVE RELIABILITY, FUNCTION OR DESIGN OR OTHERWISE.

Vishay Intertechnology, Inc., its affiliates, agents, and employees, and all persons acting on its or their behalf (collectively, "Vishay"), disclaim any and all liability for any errors, inaccuracies or incompleteness contained in any datasheet or in any other disclosure relating to any product.

Vishay makes no warranty, representation or guarantee regarding the suitability of the products for any particular purpose or the continuing production of any product. To the maximum extent permitted by applicable law, Vishay disclaims (i) any and all liability arising out of the application or use of any product, (ii) any and all liability, including without limitation special, consequential or incidental damages, and (iii) any and all implied warranties, including warranties of fitness for particular purpose, non-infringement and merchantability.

Statements regarding the suitability of products for certain types of applications are based on Vishay's knowledge of typical requirements that are often placed on Vishay products in generic applications. Such statements are not binding statements about the suitability of products for a particular application. It is the customer's responsibility to validate that a particular product with the properties described in the product specification is suitable for use in a particular application. Parameters provided in datasheets and/or specifications may vary in different applications and performance may vary over time. All operating parameters, including typical parameters, must be validated for each customer application by the customer's technical experts. Product specifications do not expand or otherwise modify Vishay's terms and conditions of purchase, including but not limited to the warranty expressed therein.

Except as expressly indicated in writing, Vishay products are not designed for use in medical, life-saving, or life-sustaining applications or for any other application in which the failure of the Vishay product could result in personal injury or death. Customers using or selling Vishay products not expressly indicated for use in such applications do so at their own risk. Please contact authorized Vishay personnel to obtain written terms and conditions regarding products designed for such applications.

No license, express or implied, by estoppel or otherwise, to any intellectual property rights is granted by this document or by any conduct of Vishay. Product names and markings noted herein may be trademarks of their respective owners.

Material Category Policy

Vishay Intertechnology, Inc. hereby certifies that all its products that are identified as RoHS-Compliant fulfill the definitions and restrictions defined under Directive 2011/65/EU of The European Parliament and of the Council of June 8, 2011 on the restriction of the use of certain hazardous substances in electrical and electronic equipment (EEE) - recast, unless otherwise specified as non-compliant.

Please note that some Vishay documentation may still make reference to RoHS Directive 2002/95/EC. We confirm that all the products identified as being compliant to Directive 2002/95/EC conform to Directive 2011/65/EU.

Vishay Intertechnology, Inc. hereby certifies that all its products that are identified as Halogen-Free follow Halogen-Free requirements as per JEDEC JS709A standards. Please note that some Vishay documentation may still make reference to the IEC 61249-2-21 definition. We confirm that all the products identified as being compliant to IEC 61249-2-21 conform to JEDEC JS709A standards.

Mouser Electronics

Authorized Distributor

Click to View Pricing, Inventory, Delivery & Lifecycle Information:

Vishay:

[1.5SMC100CA-E3/1T](#) [1.5SMC10A/9T](#) [1.5SMC11CA-E3/1T](#) [1.5SMC12CA/1T](#) [1.5SMC12CA-E3/1T](#)
[1.5SMC150CA/1T](#) [1.5SMC150CA-E3/1T](#) [1.5SMC15A-E3/1T](#) [1.5SMC15CA/1T](#) [1.5SMC15CA-E3/1T](#) [1.5SMC160A-E3/1T](#) [1.5SMC180A/1T](#) [1.5SMC180A-E3/1T](#) [1.5SMC18A-E3/1T](#) [1.5SMC200A/9T](#) [1.5SMC200A-E3/1T](#)
[1.5SMC200CA/1T](#) [1.5SMC200CA-E3/1T](#) [1.5SMC20A-E3/1T](#) [1.5SMC220A-E3/1T](#) [1.5SMC220CA-E3/1T](#) [1.5SMC22A-E3/1T](#) [1.5SMC250A/1T](#) [1.5SMC27CA/1T](#) [1.5SMC27CA-E3/1T](#) [1.5SMC30A-E3/1T](#) [1.5SMC30CA-E3/1T](#) [1.5SMC33A-E3/1T](#) [1.5SMC400A/9AT](#) [1.5SMC43A-E3/1T](#) [1.5SMC51A/9T](#) [1.5SMC51A-E3/1T](#) [1.5SMC51CA-E3/1T](#)
[1.5SMC540A/51T](#) [1.5SMC540A/9AT](#) [1.5SMC540A/9T](#) [1.5SMC56CA/9AT](#) [1.5SMC68A-E3/1T](#) [1.5SMC75CA/1T](#) [1.5SMC75CA-E3/1T](#) [1.5SMC91CA/1T](#) [1.5SMC91CA-E3/1T](#) [1.5SMC100A/57T](#) [1.5SMC100A/59T](#) [1.5SMC100A/9AT](#) [1.5SMC100A-E3/57T](#) [1.5SMC100A-E3/59T](#) [1.5SMC100A-E3/9AT](#) [1.5SMC100AHE3/57T](#) [1.5SMC100AHE3/59T](#)
[1.5SMC100AHE3/9AT](#) [1.5SMC100CA/57T](#) [1.5SMC100CA/59T](#) [1.5SMC100CA/7T](#) [1.5SMC100CA/9AT](#) [1.5SMC100CA-E3/57T](#) [1.5SMC100CA-E3/59T](#) [1.5SMC100CA-E3/9AT](#) [1.5SMC100CAHE3/57T](#)
[1.5SMC100CAHE3/59T](#) [1.5SMC100CAHE3/9AT](#) [1.5SMC10A/57T](#) [1.5SMC10A/59T](#) [1.5SMC10A/9AT](#) [1.5SMC10A-E3/57T](#) [1.5SMC10A-E3/59T](#) [1.5SMC10A-E3/9AT](#) [1.5SMC10AHE3/57T](#) [1.5SMC10AHE3/59T](#) [1.5SMC10AHE3/9AT](#)
[1.5SMC10CA/57T](#) [1.5SMC10CA/59T](#) [1.5SMC10CA/9AT](#) [1.5SMC10CA-E3/57T](#) [1.5SMC10CA-E3/59T](#) [1.5SMC10CA-E3/9AT](#) [1.5SMC10CAHE3/57T](#) [1.5SMC10CAHE3/59T](#) [1.5SMC10CAHE3/9AT](#) [1.5SMC110A/51T](#) [1.5SMC110A/57T](#) [1.5SMC110A/59T](#) [1.5SMC110A/9AT](#) [1.5SMC110A-E3/51T](#) [1.5SMC110A-E3/57T](#) [1.5SMC110A-E3/59T](#)
[1.5SMC110A-E3/9AT](#) [1.5SMC110AHE3/57T](#) [1.5SMC110AHE3/59T](#) [1.5SMC110AHE3/9AT](#) [1.5SMC110CA/57T](#) [1.5SMC110CA/59T](#) [1.5SMC110CA/7T](#) [1.5SMC110CA/9AT](#) [1.5SMC110CA-E3/57T](#) [1.5SMC110CA-E3/59T](#)
[1.5SMC110CA-E3/9AT](#) [1.5SMC110CAHE3/57T](#) [1.5SMC110CAHE3/59T](#) [1.5SMC110CAHE3/9AT](#)